



◀ **WZÓR GWOŹDZIA AZUROWEGO**
EXAMPLE OF THE OPENWORK NAIL

DOSTĘPNE ODMIANY GWOŹDZI / AVAILABLE TYPES OF NAILS

Pierwszy człon numeru katalogowego First part of REF No.	Odmiany gwoździ / Types of nails
1	tytan / titanium
2	tytan kaniulowany / cannulated titanium
3	Stalowe lite / Steel solid nails
4	stal kaniulowana / cannulated steel
5	stal kaniulowana + DLC / stainless steel + DLC
6	Azurowe / openwork nails
11	tytan + DLC / titanium + DLC
21	tytan lity pokryty Si-DLC / titanium + Si-DLC
22	tytan kaniulowany Si-DLC / cannulated titanium + Si-DLC
23	stal lita pokryta Si-DLC / steel + Si-DLC
24	stal kaniulowana pokryta Si-DLC / cannulated steel + Si-DLC

**GWÓDŹ DO KOŚCI PISZCZELOWEJ - REKONSTRUKCYJNY
RECOSTRUCTION TIBIAL NAIL**

Rozmiar Size	REF
0	X-07-95-20
+5	X-07-95-21
+10	X-07-95-22
+15	X-07-95-23
+20	X-07-95-24
+25	X-07-95-25
+30	X-07-95-26

Śruba kompresyjna
Compression screw
X-07-96-03



Śruby zaślepiające
End caps



2 Wkręty blokujące
samogwintujące \varnothing 5,0 mm
Self tapping locking screws
X-01-88-xx
lub/or

Wkręty blokujące
samogwintujące \varnothing 4,5 mm
Self tapping locking screws
X-01-86-xx

2 Wkręty blokujące
samogwintujące \varnothing 4,5 mm
Self tapping locking screws
X-01-86-xx

Wersja - lity / solid

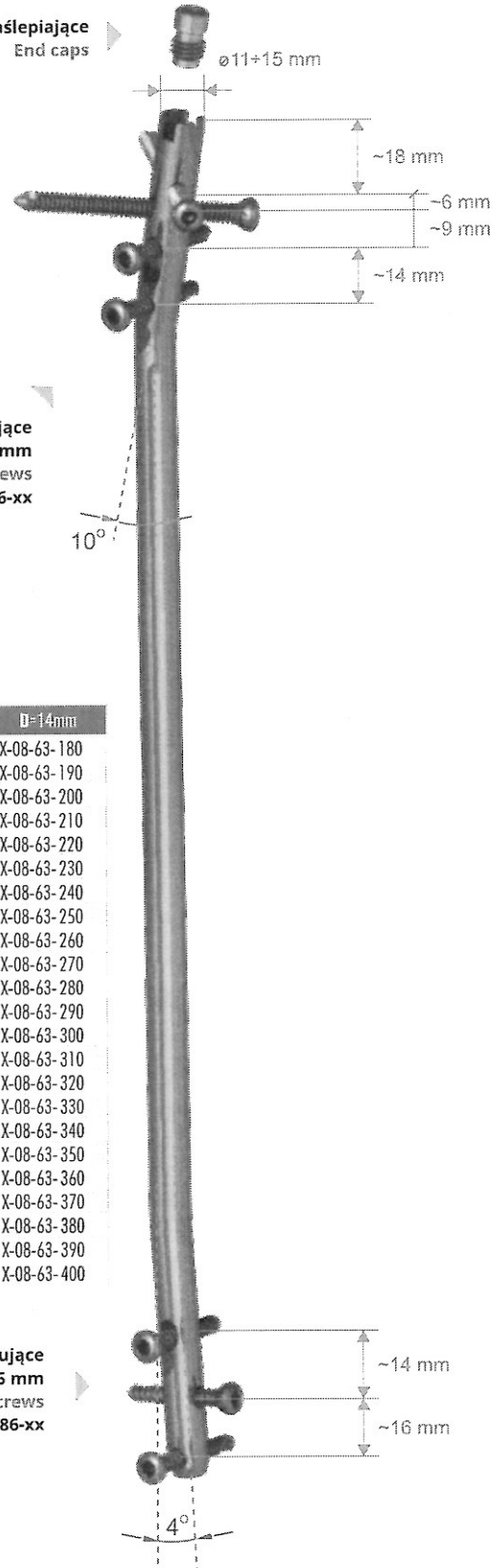
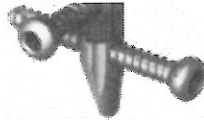

L (mm)	D=8mm	D=9mm	D=10mm	D=11mm	D=12mm	D=13mm	D=14mm
180	X-08-57-180	X-08-58-180	X-08-59-180	X-08-60-180	X-08-61-180	X-08-62-180	X-08-63-180
190	X-08-57-190	X-08-58-190	X-08-59-190	X-08-60-190	X-08-61-190	X-08-62-190	X-08-63-190
200	X-08-57-200	X-08-58-200	X-08-59-200	X-08-60-200	X-08-61-200	X-08-62-200	X-08-63-200
210	X-08-57-210	X-08-58-210	X-08-59-210	X-08-60-210	X-08-61-210	X-08-62-210	X-08-63-210
220	X-08-57-220	X-08-58-220	X-08-59-220	X-08-60-220	X-08-61-220	X-08-62-220	X-08-63-220
230	X-08-57-230	X-08-58-230	X-08-59-230	X-08-60-230	X-08-61-230	X-08-62-230	X-08-63-230
240	X-08-57-240	X-08-58-240	X-08-59-240	X-08-60-240	X-08-61-240	X-08-62-240	X-08-63-240
250	X-08-57-250	X-08-58-250	X-08-59-250	X-08-60-250	X-08-61-250	X-08-62-250	X-08-63-250
260	X-08-57-260	X-08-58-260	X-08-59-260	X-08-60-260	X-08-61-260	X-08-62-260	X-08-63-260
270	X-08-57-270	X-08-58-270	X-08-59-270	X-08-60-270	X-08-61-270	X-08-62-270	X-08-63-270
280	X-08-57-280	X-08-58-280	X-08-59-280	X-08-60-280	X-08-61-280	X-08-62-280	X-08-63-280
290	X-08-57-290	X-08-58-290	X-08-59-290	X-08-60-290	X-08-61-290	X-08-62-290	X-08-63-290
300	X-08-57-300	X-08-58-300	X-08-59-300	X-08-60-300	X-08-61-300	X-08-62-300	X-08-63-300
310	X-08-57-310	X-08-58-310	X-08-59-310	X-08-60-310	X-08-61-310	X-08-62-310	X-08-63-310
320	X-08-57-320	X-08-58-320	X-08-59-320	X-08-60-320	X-08-61-320	X-08-62-320	X-08-63-320
330	X-08-57-330	X-08-58-330	X-08-59-330	X-08-60-330	X-08-61-330	X-08-62-330	X-08-63-330
340	X-08-57-340	X-08-58-340	X-08-59-340	X-08-60-340	X-08-61-340	X-08-62-340	X-08-63-340
350	X-08-57-350	X-08-58-350	X-08-59-350	X-08-60-350	X-08-61-350	X-08-62-350	X-08-63-350
360	X-08-57-360	X-08-58-360	X-08-59-360	X-08-60-360	X-08-61-360	X-08-62-360	X-08-63-360
370	X-08-57-370	X-08-58-370	X-08-59-370	X-08-60-370	X-08-61-370	X-08-62-370	X-08-63-370
380	X-08-57-380	X-08-58-380	X-08-59-380	X-08-60-380	X-08-61-380	X-08-62-380	X-08-63-380
390	X-08-57-390	X-08-58-390	X-08-59-390	X-08-60-390	X-08-61-390	X-08-62-390	X-08-63-390
400	X-08-57-400	X-08-58-400	X-08-59-400	X-08-60-400	X-08-61-400	X-08-62-400	X-08-63-400

3 Wkręty blokujące
samogwintujące \varnothing 4,5 mm
Self tapping locking screws
X-01-86-xx

Gwoździe są dostępne dla długości L= 180 - 600 mm, skok co 5 mm, ostatni człon numeru katalogowego oznacza długość w [mm].

Gwoździe są dostępne również dla średnic D=13, 14, 15, 16 17, 18, 19 mm

Available in lengths L = 180 - 600 mm, last part of catalogue number is length in [mm]. Available also for diameter D = 13, 14, 15, 16 17, 18, 19 mm

**ŚRUBY I WKRĘTY BLOKUJĄCE DLA GWOŹDZI BLOKOWANYCH
LOCKING SCREWS FOR INTERLOCKING NAILS**

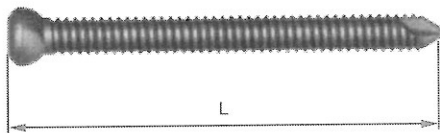

Wkręt blokujący samogwintujący \varnothing 5,0 mm
Self tapping locking screw \varnothing 5,0 mm

L (mm)	REF	L (mm)	REF
26	X-01-88-26	64	X-01-88-64
28	X-01-88-28	66	X-01-88-66
30	X-01-88-30	68	X-01-88-68
32	X-01-88-32	70	X-01-88-70
34	X-01-88-34	72	X-01-88-72
36	X-01-88-36	74	X-01-88-74
38	X-01-88-38	76	X-01-88-76
40	X-01-88-40	78	X-01-88-78
42	X-01-88-42	80	X-01-88-80
44	X-01-88-44	82	X-01-88-82
46	X-01-88-46	84	X-01-88-84
48	X-01-88-48	86	X-01-88-86
50	X-01-88-50	88	X-01-88-88
52	X-01-88-52	90	X-01-88-90
54	X-01-88-54	92	X-01-88-92
56	X-01-88-56	94	X-01-88-94
58	X-01-88-58	96	X-01-88-96
60	X-01-88-60	98	X-01-88-98
62	X-01-88-62	100	X-01-88-100

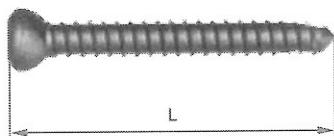

Wkręt blokujący samogwintujący \varnothing 4,5 mm
Self tapping locking screw \varnothing 4,5 mm

L (mm)	REF	L (mm)	REF
26	X-01-86-26	64	X-01-86-64
28	X-01-86-28	66	X-01-86-66
30	X-01-86-30	68	X-01-86-68
32	X-01-86-32	70	X-01-86-70
34	X-01-86-34	72	X-01-86-72
36	X-01-86-36	74	X-01-86-74
38	X-01-86-38	76	X-01-86-76
40	X-01-86-40	78	X-01-86-78
42	X-01-86-42	80	X-01-86-80
44	X-01-86-44	82	X-01-86-82
46	X-01-86-46	84	X-01-86-84
48	X-01-86-48	86	X-01-86-86
50	X-01-86-50	88	X-01-86-88
52	X-01-86-52	90	X-01-86-90
54	X-01-86-54	92	X-01-86-92
56	X-01-86-56	94	X-01-86-94
58	X-01-86-58	96	X-01-86-96
60	X-01-86-60	98	X-01-86-98
62	X-01-86-62	100	X-01-86-100

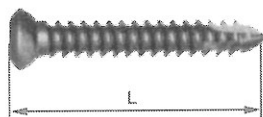

Wkręt korowy samogwintujący \varnothing 3,5 mm
Self tapping cortical screw \varnothing 3,5 mm

L (mm)	REF
10	X-01-51-10
12	X-01-51-12
14	X-01-51-14
16	X-01-51-16
18	X-01-51-18
20	X-01-51-20
22	X-01-51-22
24	X-01-51-24
26	X-01-51-26
28	X-01-51-28
30	X-01-51-30
32	X-01-51-32
34	X-01-51-34

**GWÓŹDŹ UDOWY ANATOMICZNY
ANATOMICAL FEMORAL NAIL**

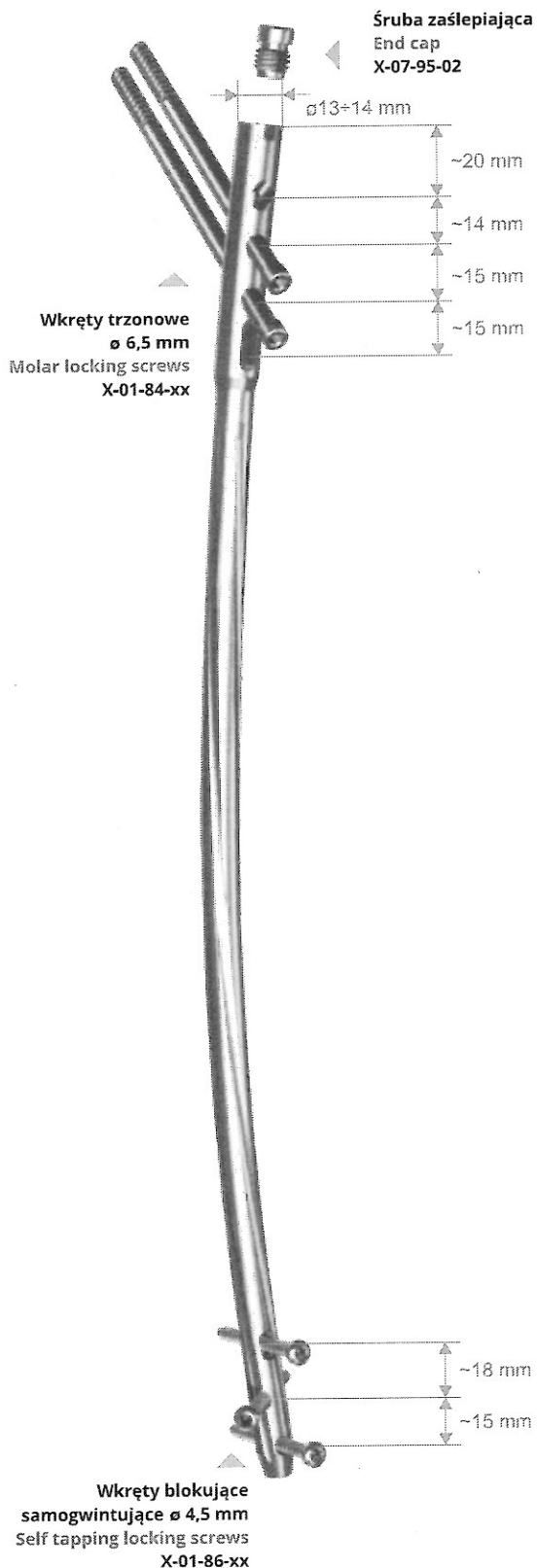

[mm]	Nr kat.
0	X-07-95-40
+5	X-07-95-41
+10	X-07-95-42
+15	X-07-95-43
+20	X-07-95-44
+25	X-07-95-45
+30	X-07-95-46

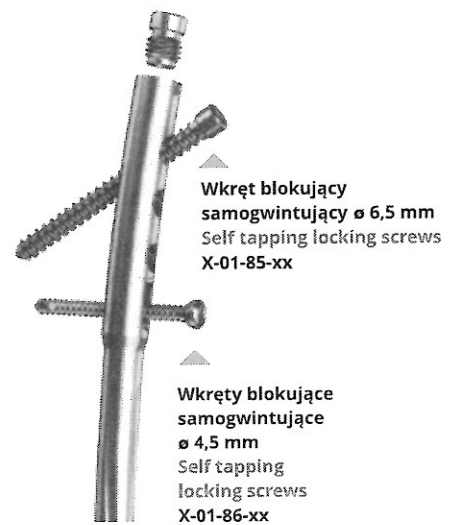

**GWÓŹDŹ LEWY
LEFT NAIL**

L (mm)	D=9mm	D=10mm	D=11mm	D=12mm
300	X-07-163-300	X-07-164-300	X-07-165-300	X-07-166-300
310	X-07-163-310	X-07-164-310	X-07-165-310	X-07-166-310
320	X-07-163-320	X-07-164-320	X-07-165-320	X-07-166-320
330	X-07-163-330	X-07-164-330	X-07-165-330	X-07-166-330
340	X-07-163-340	X-07-164-340	X-07-165-340	X-07-166-340
350	X-07-163-350	X-07-164-350	X-07-165-350	X-07-166-350
360	X-07-163-360	X-07-164-360	X-07-165-360	X-07-166-360
370	X-07-163-370	X-07-164-370	X-07-165-370	X-07-166-370
380	X-07-163-380	X-07-164-380	X-07-165-380	X-07-166-380
390	X-07-163-390	X-07-164-390	X-07-165-390	X-07-166-390
400	X-07-163-400	X-07-164-400	X-07-165-400	X-07-166-400
410	X-07-163-410	X-07-164-410	X-07-165-410	X-07-166-410
420	X-07-163-420	X-07-164-420	X-07-165-420	X-07-166-420
430	X-07-163-430	X-07-164-430	X-07-165-430	X-07-166-430
440	X-07-163-440	X-07-164-440	X-07-165-440	X-07-166-440
450	X-07-163-450	X-07-164-450	X-07-165-450	X-07-166-450
460	X-07-163-460	X-07-164-460	X-07-165-460	X-07-166-460
470	X-07-163-470	X-07-164-470	X-07-165-470	X-07-166-470
480	X-07-163-480	X-07-164-480	X-07-165-480	X-07-166-480

**GWÓŹDŹ PRAWY
RIGHT NAIL**

L (mm)	D=9mm	D=10mm	D=11mm	D=12mm
300	X-07-175-300	X-07-176-300	X-07-177-300	X-07-178-300
310	X-07-175-310	X-07-176-310	X-07-177-310	X-07-178-310
320	X-07-175-320	X-07-176-320	X-07-177-320	X-07-178-320
330	X-07-175-330	X-07-176-330	X-07-177-330	X-07-178-330
340	X-07-175-340	X-07-176-340	X-07-177-340	X-07-178-340
350	X-07-175-350	X-07-176-350	X-07-177-350	X-07-178-350
360	X-07-175-360	X-07-176-360	X-07-177-360	X-07-178-360
370	X-07-175-370	X-07-176-370	X-07-177-370	X-07-178-370
380	X-07-175-380	X-07-176-380	X-07-177-380	X-07-178-380
390	X-07-175-390	X-07-176-390	X-07-177-390	X-07-178-390
400	X-07-175-400	X-07-176-400	X-07-177-400	X-07-178-400
410	X-07-175-410	X-07-176-410	X-07-177-410	X-07-178-410
420	X-07-175-420	X-07-176-420	X-07-177-420	X-07-178-420
430	X-07-175-430	X-07-176-430	X-07-177-430	X-07-178-430
440	X-07-175-440	X-07-176-440	X-07-177-440	X-07-178-440
450	X-07-175-450	X-07-176-450	X-07-177-450	X-07-178-450
460	X-07-175-460	X-07-176-460	X-07-177-460	X-07-178-460
470	X-07-175-470	X-07-176-470	X-07-177-470	X-07-178-470
480	X-07-175-480	X-07-176-480	X-07-177-480	X-07-178-480

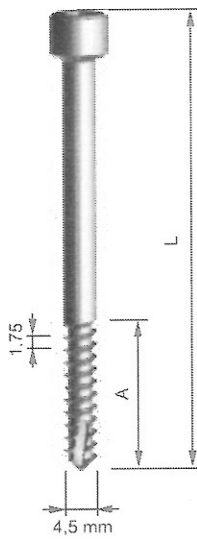
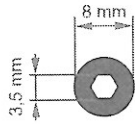

WKRĘT BLOKUJĄCY TRZONOWY samogwintujący
LOCKING SHAFT SCREW self-tapping
ø 4,5 x 1,75 mm



L (mm)	A (mm)	Ø	L (mm)	A (mm)	Ø
26	12	X-01-81-26	64	20	X-01-81-64
28	12	X-01-81-28	66	20	X-01-81-66
30	12	X-01-81-30	68	20	X-01-81-68
32	12	X-01-81-32	70	20	X-01-81-70
34	12	X-01-81-34	72	20	X-01-81-72
36	16	X-01-81-36	74	20	X-01-81-74
38	16	X-01-81-38	76	20	X-01-81-76
40	16	X-01-81-40	78	20	X-01-81-78
42	16	X-01-81-42	80	20	X-01-81-80
44	16	X-01-81-44	82	20	X-01-81-82
46	16	X-01-81-46	84	20	X-01-81-84
48	16	X-01-81-48	86	20	X-01-81-86
50	18	X-01-81-50	88	20	X-01-81-88
52	18	X-01-81-52	90	20	X-01-81-90
54	18	X-01-81-54	92	20	X-01-81-92
56	18	X-01-81-56	94	20	X-01-81-94
58	18	X-01-81-58	96	20	X-01-81-96
60	18	X-01-81-60	98	20	X-01-81-98
62	18	X-01-81-62	100	20	X-01-81-100

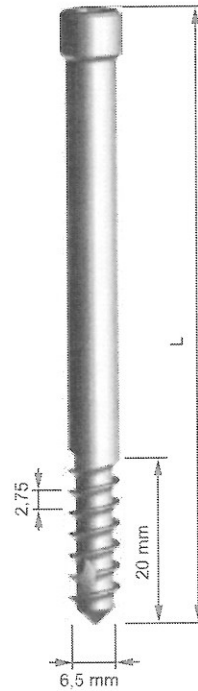
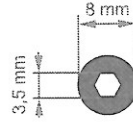

WKRĘT BLOKUJĄCY TRZONOWY samogwintujący
LOCKING SHAFT SCREW self-tapping
ø 6,5 x 2,75 mm

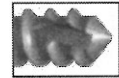

L (mm)	Ø
40	X-01-84-40
45	X-01-84-45
50	X-01-84-50
55	X-01-84-55
60	X-01-84-60
65	X-01-84-65
70	X-01-84-70
75	X-01-84-75
80	X-01-84-80
85	X-01-84-85
90	X-01-84-90
95	X-01-84-95
100	X-01-84-100
105	X-01-84-105
110	X-01-84-110
115	X-01-84-115
120	X-01-84-120
125	X-01-84-125
130	X-01-84-130
135	X-01-84-135
140	X-01-84-140

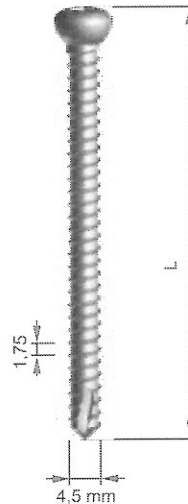
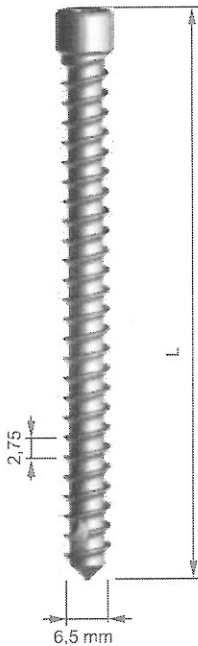
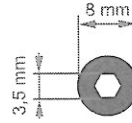
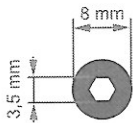

**WKRĘT BLOKUJĄCY
samogwintujący
LOCKING SCREW
self-tapping
ø 6,5 x 2,75 mm**

**WKRĘT BLOKUJĄCY
samogwintujący
LOCKING SCREW
self-tapping
ø 4,5 mm**

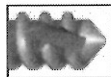

L (mm)	⊙	L (mm)	⊙
40	X-01-85-40	82	X-01-85-82
42	X-01-85-42	84	X-01-85-84
44	X-01-85-44	86	X-01-85-86
46	X-01-85-46	88	X-01-85-88
48	X-01-85-48	90	X-01-85-90
50	X-01-85-50	92	X-01-85-92
52	X-01-85-52	94	X-01-85-94
54	X-01-85-54	96	X-01-85-96
56	X-01-85-56	98	X-01-85-98
58	X-01-85-58	100	X-01-85-100
60	X-01-85-60	102	X-01-85-102
62	X-01-85-62	104	X-01-85-104
64	X-01-85-64	106	X-01-85-106
66	X-01-85-66	108	X-01-85-108
68	X-01-85-68	110	X-01-85-110
70	X-01-85-70	112	X-01-85-112
72	X-01-85-72	114	X-01-85-114
74	X-01-85-74	116	X-01-85-116
76	X-01-85-76	118	X-01-85-118
78	X-01-85-78	120	X-01-85-120
80	X-01-85-80		

L (mm)	⊙	L (mm)	⊙
16	X-01-86-16	60	X-01-86-60
18	X-01-86-18	62	X-01-86-62
20	X-01-86-20	64	X-01-86-64
22	X-01-86-22	66	X-01-86-66
24	X-01-86-24	68	X-01-86-68
26	X-01-86-26	70	X-01-86-70
28	X-01-86-28	72	X-01-86-72
30	X-01-86-30	74	X-01-86-74
32	X-01-86-32	76	X-01-86-76
34	X-01-86-34	78	X-01-86-78
36	X-01-86-36	80	X-01-86-80
38	X-01-86-38	82	X-01-86-82
40	X-01-86-40	84	X-01-86-84
42	X-01-86-42	86	X-01-86-86
44	X-01-86-44	88	X-01-86-88
46	X-01-86-46	90	X-01-86-90
48	X-01-86-48	92	X-01-86-92
50	X-01-86-50	94	X-01-86-94
52	X-01-86-52	96	X-01-86-96
54	X-01-86-54	98	X-01-86-98
56	X-01-86-56	100	X-01-86-100
58	X-01-86-58		

**GWÓDŹ UDOWY UNIWERSALNY
UNIVERSAL FEMORAL NAIL**

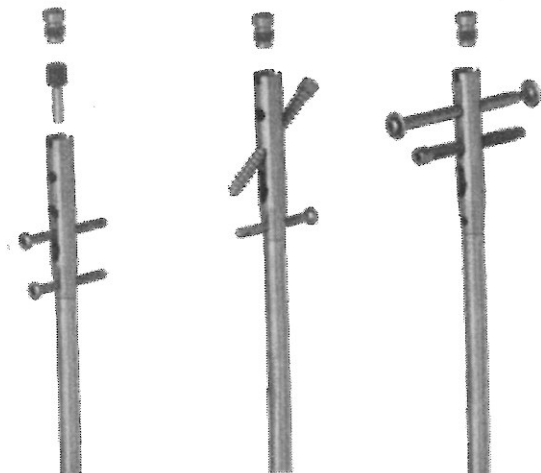
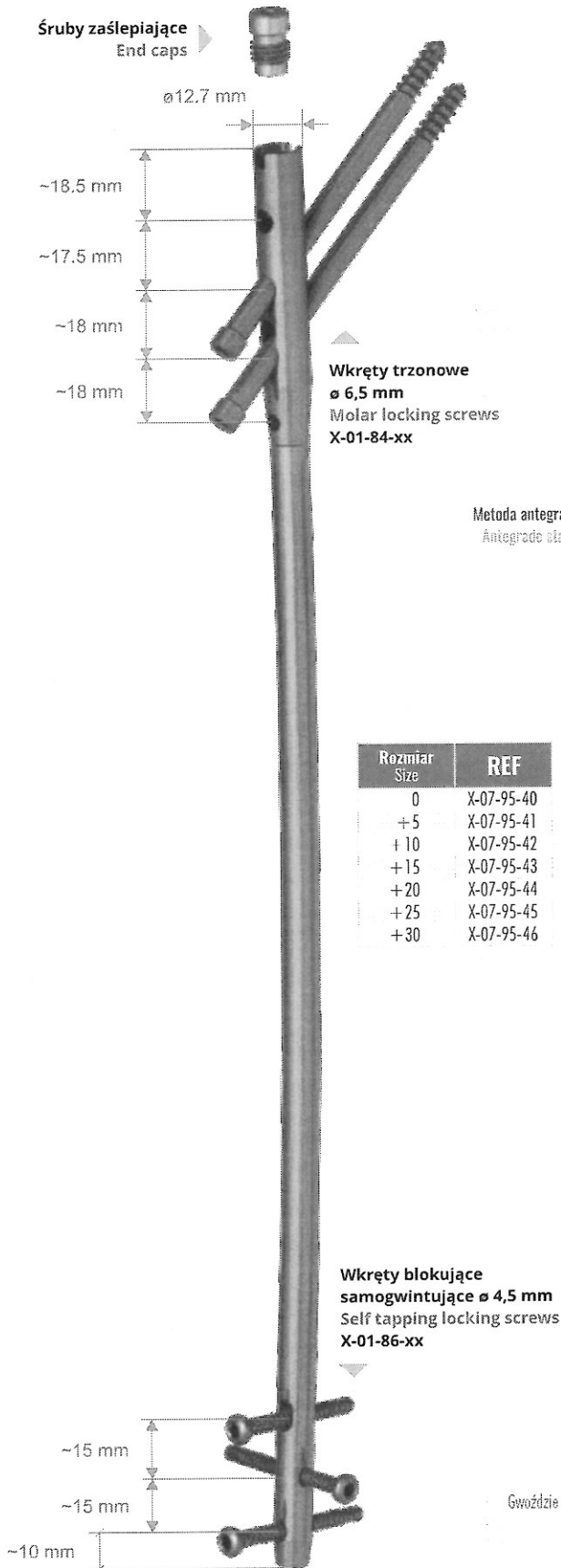

Metoda antegrade, statyczna i kompresyjna
Antegrade static & compression method

Metoda antegrade skośna
Antegrade oblique screws

Metoda odkolanowa
Retrograde method

Roźmiar Size	REF
0	X-07-95-40
+5	X-07-95-41
+10	X-07-95-42
+15	X-07-95-43
+20	X-07-95-44
+25	X-07-95-45
+30	X-07-95-46

L (mm)	D=9mm	D=10mm	D=11mm	D=12mm
GWÓDŹ LEWY / LEFT NAIL				
200	X-07-305-200	X-07-306-200	X-07-307-200	X-07-308-200
220	X-07-305-220	X-07-306-220	X-07-307-220	X-07-308-220
240	X-07-305-240	X-07-306-240	X-07-307-240	X-07-308-240
260	X-07-305-260	X-07-306-260	X-07-307-260	X-07-308-260
280	X-07-305-280	X-07-306-280	X-07-307-280	X-07-308-280
300	X-07-305-300	X-07-306-300	X-07-307-300	X-07-308-300
320	X-07-305-320	X-07-306-320	X-07-307-320	X-07-308-320
340	X-07-305-340	X-07-306-340	X-07-307-340	X-07-308-340
360	X-07-305-360	X-07-306-360	X-07-307-360	X-07-308-360
380	X-07-305-380	X-07-306-380	X-07-307-380	X-07-308-380
400	X-07-305-400	X-07-306-400	X-07-307-400	X-07-308-400
420	X-07-305-420	X-07-306-420	X-07-307-420	X-07-308-420
440	X-07-305-440	X-07-306-440	X-07-307-440	X-07-308-440
460	X-07-305-460	X-07-306-460	X-07-307-460	X-07-308-460
480	X-07-305-480	X-07-306-480	X-07-307-480	X-07-308-480
500	X-07-305-500	X-07-306-500	X-07-307-500	X-07-308-500
GWÓDŹ PRAWY / RIGHT NAIL				
200	X-07-317-200	X-07-318-200	X-07-319-200	X-07-320-200
220	X-07-317-220	X-07-318-220	X-07-319-220	X-07-320-220
240	X-07-317-240	X-07-318-240	X-07-319-240	X-07-320-240
260	X-07-317-260	X-07-318-260	X-07-319-260	X-07-320-260
280	X-07-317-280	X-07-318-280	X-07-319-280	X-07-320-280
300	X-07-317-300	X-07-318-300	X-07-319-300	X-07-320-300
320	X-07-317-320	X-07-318-320	X-07-319-320	X-07-320-320
340	X-07-317-340	X-07-318-340	X-07-319-340	X-07-320-340
360	X-07-317-360	X-07-318-360	X-07-319-360	X-07-320-360
380	X-07-317-380	X-07-318-380	X-07-319-380	X-07-320-380
400	X-07-317-400	X-07-318-400	X-07-319-400	X-07-320-400
420	X-07-317-420	X-07-318-420	X-07-319-420	X-07-320-420
440	X-07-317-440	X-07-318-440	X-07-319-440	X-07-320-440
460	X-07-317-460	X-07-318-460	X-07-319-460	X-07-320-460
480	X-07-317-480	X-07-318-480	X-07-319-480	X-07-320-480
500	X-07-317-500	X-07-318-500	X-07-319-500	X-07-320-500

Gwoździe są dostępne dla długości co 10 mm, ostatni człon numeru katalogowego oznacza długość w [mm]
Gwoździe są dostępne również dla średnic D=8, 14, 15, 16, 17, 18, 19 mm
Available also for diameter D = 8, 14, 15, 16, 17, 18, 19 mm

**GWÓDZIE UDOWY ODKOLANOWY
RETROGRADE FEMORAL NAIL**

**Wkręty blokujące
samogwintujące
ø 4,5 mm
Self tapping
locking screws
X-01-86-xx**

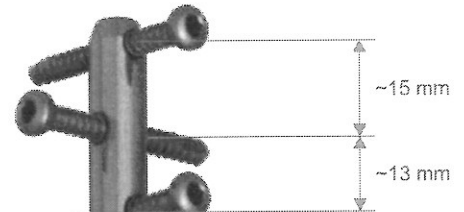

L (mm)	D=8mm	D=9mm	D=10mm	D=11mm	D=12mm	D=13mm
140	X-07-100-140	X-07-101-140	X-07-102-140	X-07-103-140	X-07-104-140	X-07-105-140
150	X-07-100-150	X-07-101-150	X-07-102-150	X-07-103-150	X-07-104-150	X-07-105-150
160	X-07-100-160	X-07-101-160	X-07-102-160	X-07-103-160	X-07-104-160	X-07-105-160
170	X-07-100-170	X-07-101-170	X-07-102-170	X-07-103-170	X-07-104-170	X-07-105-170
180	X-07-100-180	X-07-101-180	X-07-102-180	X-07-103-180	X-07-104-180	X-07-105-180
190	X-07-100-190	X-07-101-190	X-07-102-190	X-07-103-190	X-07-104-190	X-07-105-190
200	X-07-100-200	X-07-101-200	X-07-102-200	X-07-103-200	X-07-104-200	X-07-105-200
210	X-07-100-210	X-07-101-210	X-07-102-210	X-07-103-210	X-07-104-210	X-07-105-210
220	X-07-100-220	X-07-101-220	X-07-102-220	X-07-103-220	X-07-104-220	X-07-105-220
230	X-07-100-230	X-07-101-230	X-07-102-230	X-07-103-230	X-07-104-230	X-07-105-230
240	X-07-100-240	X-07-101-240	X-07-102-240	X-07-103-240	X-07-104-240	X-07-105-240
250	X-07-100-250	X-07-101-250	X-07-102-250	X-07-103-250	X-07-104-250	X-07-105-250
260	X-07-100-260	X-07-101-260	X-07-102-260	X-07-103-260	X-07-104-260	X-07-105-260
270	X-07-100-270	X-07-101-270	X-07-102-270	X-07-103-270	X-07-104-270	X-07-105-270
280	X-07-100-280	X-07-101-280	X-07-102-280	X-07-103-280	X-07-104-280	X-07-105-280
290	X-07-100-290	X-07-101-290	X-07-102-290	X-07-103-290	X-07-104-290	X-07-105-290
300	X-07-100-300	X-07-101-300	X-07-102-300	X-07-103-300	X-07-104-300	X-07-105-300
310	X-07-100-310	X-07-101-310	X-07-102-310	X-07-103-310	X-07-104-310	X-07-105-310
320	X-07-100-320	X-07-101-320	X-07-102-320	X-07-103-320	X-07-104-320	X-07-105-320
330	X-07-100-330	X-07-101-330	X-07-102-330	X-07-103-330	X-07-104-330	X-07-105-330
340	X-07-100-340	X-07-101-340	X-07-102-340	X-07-103-340	X-07-104-340	X-07-105-340
350	X-07-100-350	X-07-101-350	X-07-102-350	X-07-103-350	X-07-104-350	X-07-105-350
360	X-07-100-360	X-07-101-360	X-07-102-360	X-07-103-360	X-07-104-360	X-07-105-360
370	X-07-100-370	X-07-101-370	X-07-102-370	X-07-103-370	X-07-104-370	X-07-105-370
380	X-07-100-380	X-07-101-380	X-07-102-380	X-07-103-380	X-07-104-380	X-07-105-380
390	X-07-100-390	X-07-101-390	X-07-102-390	X-07-103-390	X-07-104-390	X-07-105-390
400	X-07-100-400	X-07-101-400	X-07-102-400	X-07-103-400	X-07-104-400	X-07-105-400
410	X-07-100-410	X-07-101-410	X-07-102-410	X-07-103-410	X-07-104-410	X-07-105-410
420	X-07-100-420	X-07-101-420	X-07-102-420	X-07-103-420	X-07-104-420	X-07-105-420
430	X-07-100-430	X-07-101-430	X-07-102-430	X-07-103-430	X-07-104-430	X-07-105-430
440	X-07-100-440	X-07-101-440	X-07-102-440	X-07-103-440	X-07-104-440	X-07-105-440

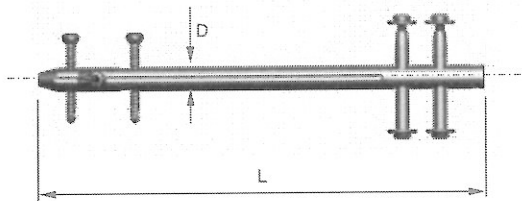

**Wkręt blokujący
samogwintujący ø 6,5 mm
Self tapping locking screws
X-01-85-xx**

LUB/OR

**Zespoły blokujące
Locking set
50-105 mm
X-01-66-xx**

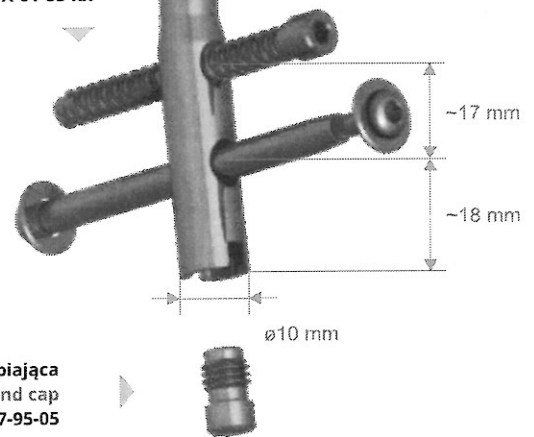

**Śruba zaślepiająca
End cap
X-07-95-05**

RANGE (mm)	REF
50-60	X-01-66-50
60-75	X-01-66-60
70-85	X-01-66-70
80-95	X-01-66-80
90-105	X-01-66-90

Gwoździe są dostępne dla długości L = 140 - 600 mm, skok co 5 mm, ostatni człon numeru katalogowego oznacza długość w [mm]. Gwoździe są dostępne również dla średnic D: 8 - 19 mm
Available in lengths L = 140 - 600 mm, last part of catalogue number is length in [mm]. Available also for diameter D: 8 - 19 mm

GWOŹDŹ DO KOŚCI RAMIENNEJ
HUMERAL NAIL

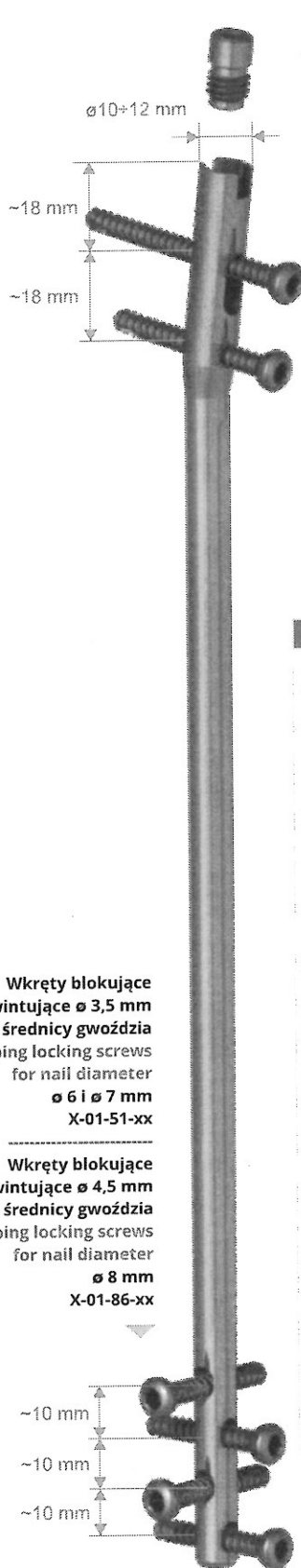

Śruby zaślepiające
End caps



Śruba kompresyjna
Compression screw
X-07-96-05

Wkręty blokujące
samogwintujące ø 4,5 mm
dł. 26-60 mm
Self tapping locking screws
X-01-86-xx

Rozmiar Size	REF
0	X-07-95-30
+5	X-07-95-31
+10	X-07-95-32
+15	X-07-95-33
+20	X-07-95-34
+25	X-07-95-35
+30	X-07-95-36

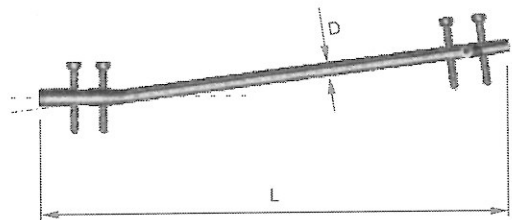

Wkręty blokujące
samogwintujące ø 3,5 mm
dla średnicy gwoźdza
Self tapping locking screws
for nail diameter
ø 6 i ø 7 mm
X-01-51-xx

Wkręty blokujące
samogwintujące ø 4,5 mm
dla średnicy gwoźdza
Self tapping locking screws
for nail diameter
ø 8 mm
X-01-86-xx

L (mm)	D=6mm	D=7mm	D=8mm	D=9mm	D=10mm	D=11mm	D=12mm
180	X-09-07-180	X-09-08-180	X-09-01-180	X-09-02-180	X-09-03-180	X-09-04-180	X-09-05-180
185	X-09-07-185	X-09-08-185	X-09-01-185	X-09-02-185	X-09-03-185	X-09-04-185	X-09-05-185
190	X-09-07-190	X-09-08-190	X-09-01-190	X-09-02-190	X-09-03-190	X-09-04-190	X-09-05-190
195	X-09-07-195	X-09-08-195	X-09-01-195	X-09-02-195	X-09-03-195	X-09-04-195	X-09-05-195
200	X-09-07-200	X-09-08-200	X-09-01-200	X-09-02-200	X-09-03-200	X-09-04-200	X-09-05-200
205	X-09-07-205	X-09-08-205	X-09-01-205	X-09-02-205	X-09-03-205	X-09-04-205	X-09-05-205
210	X-09-07-210	X-09-08-210	X-09-01-210	X-09-02-210	X-09-03-210	X-09-04-210	X-09-05-210
215	X-09-07-215	X-09-08-215	X-09-01-215	X-09-02-215	X-09-03-215	X-09-04-215	X-09-05-215
220	X-09-07-220	X-09-08-220	X-09-01-220	X-09-02-220	X-09-03-220	X-09-04-220	X-09-05-220
225	X-09-07-225	X-09-08-225	X-09-01-225	X-09-02-225	X-09-03-225	X-09-04-225	X-09-05-225
230	X-09-07-230	X-09-08-230	X-09-01-230	X-09-02-230	X-09-03-230	X-09-04-230	X-09-05-230
235	X-09-07-235	X-09-08-235	X-09-01-235	X-09-02-235	X-09-03-235	X-09-04-235	X-09-05-235
240	X-09-07-240	X-09-08-240	X-09-01-240	X-09-02-240	X-09-03-240	X-09-04-240	X-09-05-240
245	X-09-07-245	X-09-08-245	X-09-01-245	X-09-02-245	X-09-03-245	X-09-04-245	X-09-05-245
250	X-09-07-250	X-09-08-250	X-09-01-250	X-09-02-250	X-09-03-250	X-09-04-250	X-09-05-250
255	X-09-07-255	X-09-08-255	X-09-01-255	X-09-02-255	X-09-03-255	X-09-04-255	X-09-05-255
260	X-09-07-260	X-09-08-260	X-09-01-260	X-09-02-260	X-09-03-260	X-09-04-260	X-09-05-260
265	X-09-07-265	X-09-08-265	X-09-01-265	X-09-02-265	X-09-03-265	X-09-04-265	X-09-05-265
270	X-09-07-270	X-09-08-270	X-09-01-270	X-09-02-270	X-09-03-270	X-09-04-270	X-09-05-270
275	X-09-07-275	X-09-08-275	X-09-01-275	X-09-02-275	X-09-03-275	X-09-04-275	X-09-05-275
280	X-09-07-280	X-09-08-280	X-09-01-280	X-09-02-280	X-09-03-280	X-09-04-280	X-09-05-280
285	X-09-07-285	X-09-08-285	X-09-01-285	X-09-02-285	X-09-03-285	X-09-04-285	X-09-05-285
290	X-09-07-290	X-09-08-290	X-09-01-290	X-09-02-290	X-09-03-290	X-09-04-290	X-09-05-290
295	X-09-07-295	X-09-08-295	X-09-01-295	X-09-02-295	X-09-03-295	X-09-04-295	X-09-05-295
300	X-09-07-300	X-09-08-300	X-09-01-300	X-09-02-300	X-09-03-300	X-09-04-300	X-09-05-300
310	X-09-07-310	X-09-08-310	X-09-01-310	X-09-02-310	X-09-03-310	X-09-04-310	X-09-05-310
320	X-09-07-320	X-09-08-320	X-09-01-320	X-09-02-320	X-09-03-320	X-09-04-320	X-09-05-320
330	X-09-07-330	X-09-08-330	X-09-01-330	X-09-02-330	X-09-03-330	X-09-04-330	X-09-05-330
340	X-09-07-340	X-09-08-340	X-09-01-340	X-09-02-340	X-09-03-340	X-09-04-340	X-09-05-340
350	X-09-07-350	X-09-08-350	X-09-01-350	X-09-02-350	X-09-03-350	X-09-04-350	X-09-05-350
360	X-09-07-360	X-09-08-360	X-09-01-360	X-09-02-360	X-09-03-360	X-09-04-360	X-09-05-360
370	X-09-07-370	X-09-08-370	X-09-01-370	X-09-02-370	X-09-03-370	X-09-04-370	X-09-05-370
380	X-09-07-380	X-09-08-380	X-09-01-380	X-09-02-380	X-09-03-380	X-09-04-380	X-09-05-380
390	X-09-07-390	X-09-08-390	X-09-01-390	X-09-02-390	X-09-03-390	X-09-04-390	X-09-05-390
400	X-09-07-400	X-09-08-400	X-09-01-400	X-09-02-400	X-09-03-400	X-09-04-400	X-09-05-400

Gwoździe są dostępne dla długości L= 180 - 600mm, skok co 5 mm, ostatni człon numeru katalogowego oznacza długość w [mm]. Gwoździe są dostępne również dla średnic D= 6, 7, 12, 13 mm
Available in lengths L = 180 - 600 mm, last part of catalogue number is length in [mm]. Available also for diameter D = 6, 7, 12, 13 mm

PŁYTKI BLOKOWANE

LOCKING PLATES

Pierwszy człon numeru katalogowego First part of REF No.	Odmiany płytek / Types of plates
1	Tytan / Titanium
4	Stal / Steel
5	Stal DLC / Steel + DLC
11	Tytan DLC / Titanium + DLC
21	Tytan Si-DLC / Titanium + Si-DLC
24	Stal Si-DLC / Steel + Si-DLC

PRZYKŁAD / EXAMPLE

X-zz-zzz-zz

X = 1,4,5,11,21,24

z = numeracja / number

L (mm)	otwory holes	Nr kat. Ref. no.
59	4	X-02-117-04
72	5	X-02-117-05
85	6	X-02-117-06
98	7	X-02-117-07
111	8	X-02-117-08
124	9	X-02-117-09
137	10	X-02-117-10
150	11	X-02-117-11
163	12	X-02-117-12

Płytką prostą wąską, grubą z ograniczonym kontaktem
Straight thick narrow plate with limited contact

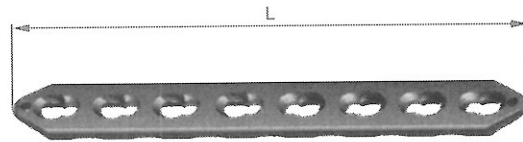

Wkręty blokowane / Locked screws: \varnothing 3,5 mm
Wkręty korowe / Cortical screw: \varnothing 3,5 mm
Wkręty gąbczaste / Cancellous screw: \varnothing 4,0 mm

L (mm)	otwory holes	Nr kat. Ref. no.
85	5	X-02-118-05
100	6	X-02-118-06
115	7	X-02-118-07
130	8	X-02-118-08
145	9	X-02-118-09
160	10	X-02-118-10
175	11	X-02-118-11
190	12	X-02-118-12
205	13	X-02-118-13
220	14	X-02-118-14
235	15	X-02-118-15
250	16	X-02-118-16
265	17	X-02-118-17
280	18	X-02-118-18

Płytką prostą, cienką, wąską
Straight thin narrow plate

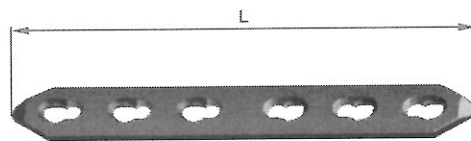

Wkręty blokowane / Locked screws: \varnothing 3,5 mm
Wkręty korowe / Cortical screw: \varnothing 3,5 mm
Wkręty gąbczaste / Cancellous screw: \varnothing 4,0 mm

L (mm)	otwory holes	Nr kat. Ref. no.
103	5	X-02-113-05
122	6	X-02-113-06
141	7	X-02-113-07
160	8	X-02-113-08
179	9	X-02-113-09
198	10	X-02-113-10
217	11	X-02-113-11
236	12	X-02-113-12
255	13	X-02-113-13
274	14	X-02-113-14
293	15	X-02-113-15
312	16	X-02-113-16
331	17	X-02-113-17
350	18	X-02-113-18

Płytką prostą szeroką z ograniczonym kontaktem
Straight wide plate with limited contact

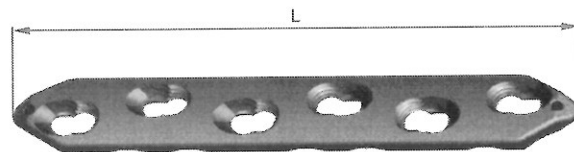

Wkręty blokowane / Locked screws: \varnothing 5,0 mm
Wkręty korowe / Cortical screw: \varnothing 4,5 mm

Płytki tubularna
Tubular plate

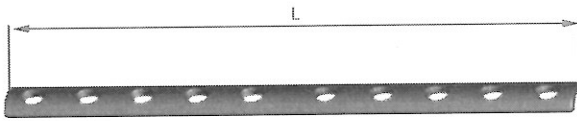

grubość
thickness
1,8 mm

L (mm)	otwory holes	Nr kat. Ref. no.
28	2	X-02-147-02
40	3	X-02-147-03
52	4	X-02-147-04
64	5	X-02-147-05
76	6	X-02-147-06
88	7	X-02-147-07
100	8	X-02-147-08
112	9	X-02-147-09
124	10	X-02-147-10
148	12	X-02-147-12

Wkręty blokowane / Locked screws: \varnothing 3,5 mm

Płytki do złamań przynasadowych
Metaphyseal plate

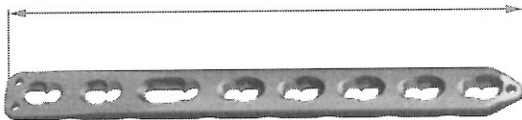

L (mm)	otwory holes	Nr kat. Ref. no.
86	6	X-02-168-06
99	7	X-02-168-07
112	8	X-02-168-08
125	9	X-02-168-09
138	10	X-02-168-10
151	11	X-02-168-11
164	12	X-02-168-12
190	14	X-02-168-14
216	16	X-02-168-16
242	18	X-02-168-18

Wkręty blokowane / Locked screws: \varnothing 3,5 mm
Wkręty korowe / Cortical screw: \varnothing 3,5 mm

Płytki do złamań przynasadowych
Metaphyseal plate

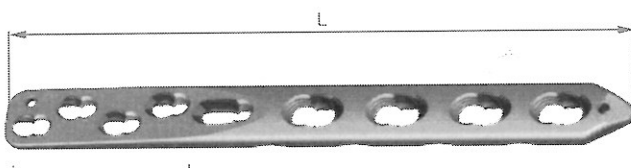

Wkręty blokowane / Locked screws: \varnothing 3,5 mm
Wkręty korowe / Cortical screw: \varnothing 3,5 mm

L (mm)	otwory holes	Nr kat. Ref. no.
118	3	X-02-167-03
136	4	X-02-167-04
154	5	X-02-167-05
172	6	X-02-167-06
190	7	X-02-167-07
208	8	X-02-167-08
226	9	X-02-167-09
262	11	X-02-167-11
298	13	X-02-167-13
334	15	X-02-167-15

Wkręty blokowane / Locked screws: \varnothing 5,0 mm
Wkręty korowe / Cortical screw: \varnothing 4,5 mm



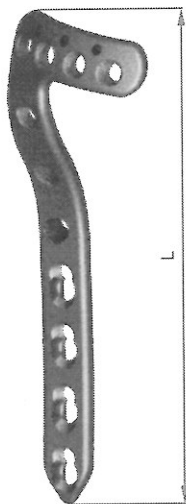

Płytkę piszczelowa bliższa boczna
Proximal lateral tibial plate

L (mm)	otwory holes	LEWA / LEFT	PRAWA / RIGHT
81	4	X-04-205-04	X-04-206-04
107	6	X-04-205-06	X-04-206-06
133	8	X-04-205-08	X-04-206-08
159	10	X-04-205-10	X-04-206-10
185	12	X-04-205-12	X-04-206-12
211	14	X-04-205-14	X-04-206-14
237	16	X-04-205-16	X-04-206-16

Wkręty blokowane / Locked screws: \varnothing 3,5 mm
Wkręty korowe / Cortical screw: \varnothing 3,5 mm

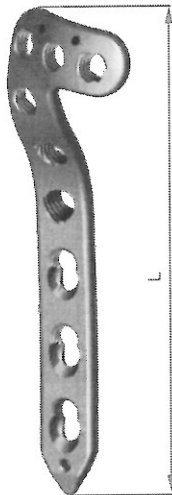

L (mm)	otwory holes	LEWA / LEFT	PRAWA / RIGHT
82	4	X-04-207-04	X-04-208-04
118	6	X-04-207-06	X-04-208-06
154	8	X-04-207-08	X-04-208-08
190	10	X-04-207-10	X-04-208-10
226	12	X-04-207-12	X-04-208-12
262	14	X-04-207-14	X-04-208-14
298	16	X-04-207-16	X-04-208-16

Wkręty blokowane / Locked screws: \varnothing 5,0 mm
Wkręty korowe / Cortical screw: \varnothing 4,5 mm

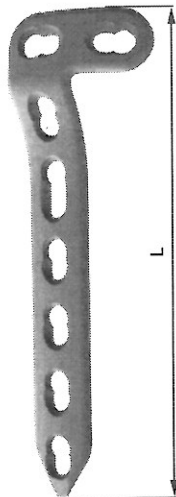

Płytkę piszczelowa podporowa L
Tibial buttress plate - L

L (mm)	otwory holes	LEWA / LEFT	PRAWA / RIGHT
69	3	X-04-219-03	X-04-220-03
85	4	X-04-219-04	X-04-220-04
101	5	X-04-219-05	X-04-220-05
117	6	X-04-219-06	X-04-220-06

Wkręty blokowane / Locked screws: \varnothing 5,0 mm
Wkręty korowe / Cortical screw: \varnothing 4,5 mm

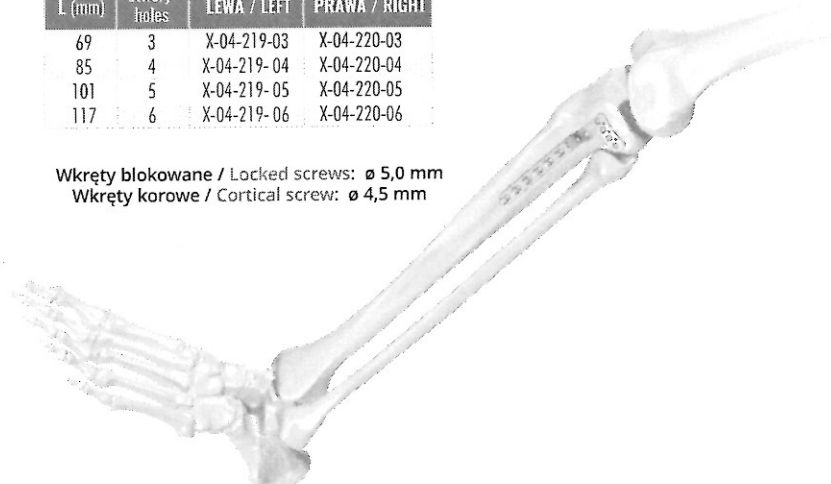

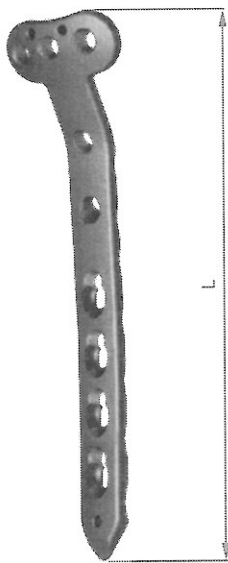

Płytkę piszczelowa bliższa przyśrodkowa
Proximal medial tibial plate

L (mm)	otwory holes	LEWA / LEFT	PRAWA / RIGHT
93	4	X-04-115-04	X-04-116-04
119	6	X-04-115-06	X-04-116-06
145	8	X-04-115-08	X-04-116-08
171	10	X-04-115-10	X-04-116-10
197	12	X-04-115-12	X-04-116-12
223	14	X-04-115-14	X-04-116-14
249	16	X-04-115-16	X-04-116-16
275	18	X-04-115-18	X-04-116-18
301	20	X-04-115-20	X-04-116-20

Wkręty blokowane / Locked screws: \varnothing 3,5 mm
Wkręty korowe / Cortical screw: \varnothing 3,5 mm

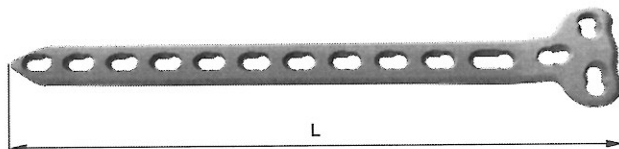

Płytkę piszczelowa T
Tibial plate - T

L (mm)	otwory holes	Nr kat. Ref. no.
68	3	X-04-222-03
84	4	X-04-222-04
100	5	X-04-222-05
116	6	X-04-222-06
132	7	X-04-222-07
148	8	X-04-222-08
180	10	X-04-222-10
212	12	X-04-222-12

Wkręty blokowane / Locked screws: \varnothing 5,0 mm
Wkręty korowe / Cortical screw: \varnothing 4,5 mm

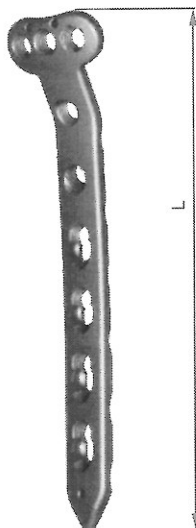

Płytkę piszczelowa bliższa przyśrodkowa
Proximal medial tibial plate

L (mm)	otwory holes	LEWA / LEFT	PRAWA / RIGHT
106	4	X-04-06-04	X-04-09-04
142	6	X-04-06-06	X-04-09-06
178	8	X-04-06-08	X-04-09-08
214	10	X-04-06-10	X-04-09-10
250	12	X-04-06-12	X-04-09-12
286	14	X-04-06-14	X-04-09-14
322	16	X-04-06-16	X-04-09-16

Wkręty blokowane / Locked screws: \varnothing 5,0 mm
Wkręty korowe / Cortical screw: \varnothing 4,5 mm

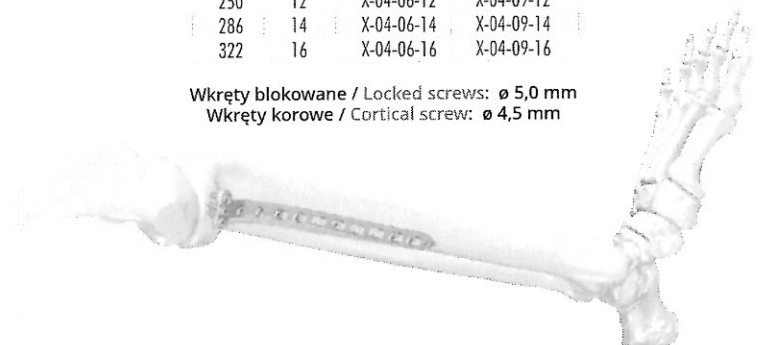

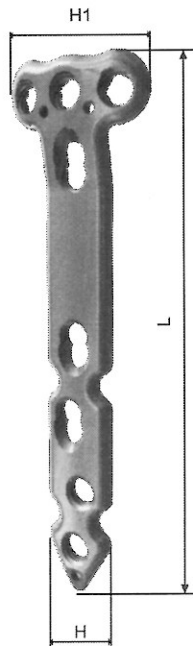

Płytko do wysokiej osteotomii kości piszczelowej
High tibial osteotomy plate

L (mm)	H (mm)	H1 (mm)	Nr kat. Ref. no.
115	16	33	X-04-217-04
112	14	30	X-04-218-112

Wkręty blokowane / Locked screws: \varnothing 5,0 mm
Wkręty korowe / Cortical screw: \varnothing 4,5 mm

Płytko kłyckiowa piszczelowa
Condylar tibial proximal plate

L (mm)	otwory holes	LEWA / LEFT	PRAWA / RIGHT
100	3	X-04-176-03	X-04-177-03
120	4	X-04-176-04	X-04-177-04
140	5	X-04-176-05	X-04-177-05
180	7	X-04-176-07	X-04-177-07
220	9	X-04-176-09	X-04-177-09
260	11	X-04-176-11	X-04-177-11
300	13	X-04-176-13	X-04-177-13

Wkręty blokowane / Locked screws: \varnothing 5,0 mm
Wkręty korowe / Cortical screw: \varnothing 4,5 mm

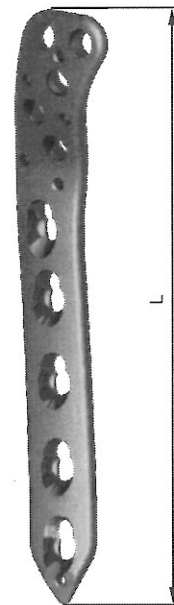

Płytko do kości piszczelowej bliższa tylno-przyśrodkowa
Proximal posterior medial tibial bone plate

L (mm)	otwory holes	Nr kat. Ref. no.
69	1	X-04-178-01
79	2	X-04-178-02
105	4	X-04-178-04
131	6	X-04-178-06
157	8	X-04-178-08
183	10	X-04-178-10

Wkręty blokowane / Locked screws: \varnothing 3,5 mm
Wkręty korowe / Cortical screw: \varnothing 3,5 mm

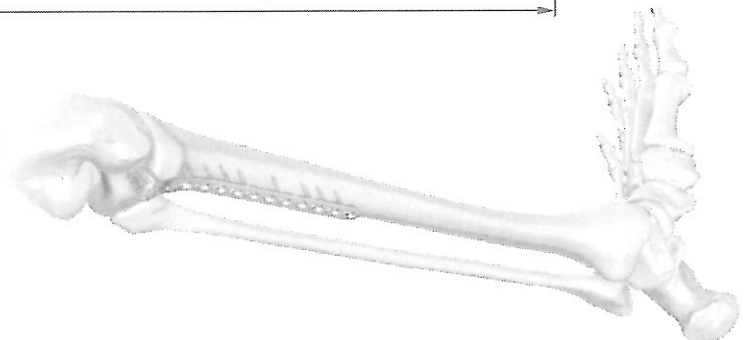
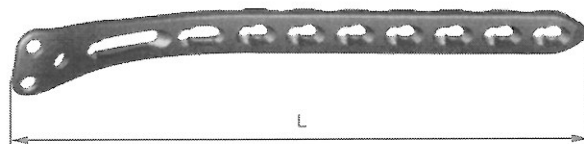

Płytkę piszczelowa podporowa T
Tibial buttress plate - T

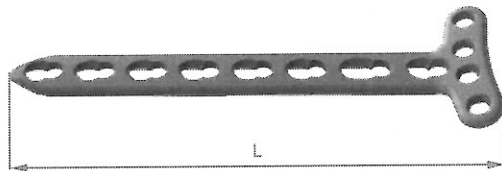

L (mm)	otwory holes	Nr kał. Ref. no.
50	4/3	X-04-221-43
56	4/4	X-04-221-44
67	4/5	X-04-221-45
78	4/6	X-04-221-46
89	4/7	X-04-221-47
100	4/8	X-04-221-48

Wkręty blokowane / Locked screws: \varnothing 3,5 mm
Wkręty korowe / Cortical screw: \varnothing 3,5 mm

Płytkę piszczelowa dalsza przyśrodkowa- standard
Distal medial tibial plate - standard

L (mm)	otwory holes	LEWA / LEFT	PRAWA / RIGHT
116	4	X-04-84-04	X-04-85-04
142	6	X-04-84-06	X-04-85-06
168	8	X-04-84-08	X-04-85-08
194	10	X-04-84-10	X-04-85-10
220	12	X-04-84-12	X-04-85-12
246	14	X-04-84-14	X-04-85-14

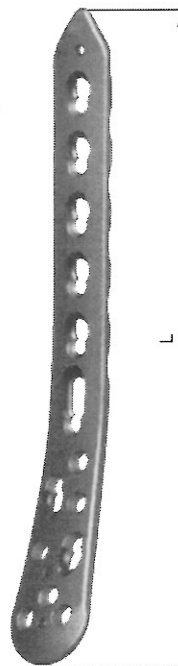

Płytkę piszczelowa dalsza przyśrodkowa z małym anatomicznym wygięciem
Distal medial tibial plate with small anatomical bend

L (mm)	otwory holes	LEWA / LEFT	PRAWA / RIGHT
109	4	X-04-117-04	X-04-118-04
135	6	X-04-117-06	X-04-118-06
161	8	X-04-117-08	X-04-118-08
187	10	X-04-117-10	X-04-118-10
213	12	X-04-117-12	X-04-118-12
239	14	X-04-117-14	X-04-118-14

Wkręty blokowane / Locked screws: \varnothing 3,5 mm
Wkręty korowe / Cortical screw: \varnothing 3,5 ; 2,7 mm

Płytkę piszczelowa dalsza przyśrodkowa z hakiem
Distal medial tibial plate with hook



L (mm)	otwory holes	LEWA / LEFT	PRAWA / RIGHT
117	4	X-04-86-04	X-04-87-04
144	6	X-04-86-06	X-04-87-06
171	8	X-04-86-08	X-04-87-08
198	10	X-04-86-10	X-04-87-10
225	12	X-04-86-12	X-04-87-12
252	14	X-04-86-14	X-04-87-14

Wkręty blokowane / Locked screws: \varnothing 3,5 mm
Wkręty korowe / Cortical screw: \varnothing 3,5 ; 2,7 mm

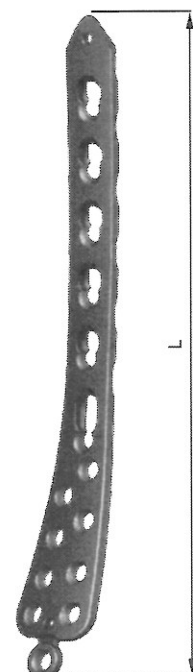

Płytki piszczelowa dalsza przednio-boczna
 Distal tibial plate, antriolateral

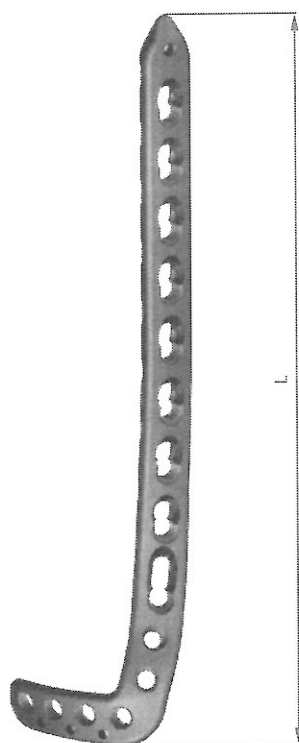

L (mm)	otwory holes	LEWA / LEFT	PRAWA / RIGHT
80	5	X-04-175-80	X-04-174-80
106	7	X-04-175-106	X-04-174-106
132	9	X-04-175-132	X-04-174-132
158	11	X-04-175-158	X-04-174-158
184	13	X-04-175-184	X-04-174-184
210	15	X-04-175-210	X-04-174-210
236	17	X-04-175-236	X-04-174-236
262	19	X-04-175-262	X-04-174-262
288	21	X-04-175-288	X-04-174-288

Wkręty blokowane / Locked screws: \varnothing 3,5 mm
 Wkręty korowe / Cortical screw: \varnothing 3,5 mm



Płytkę do kości strzałkowej dalsza boczna
 Distal lateral fibula bone plate

L (mm)	otwory / holes	LEWA / LEFT	PRAWA / RIGHT
73	3	X-04-229-03	X-04-230-03
86	4	X-04-229-04	X-04-230-04
99	5	X-04-229-05	X-04-230-05
112	6	X-04-229-06	X-04-230-06
125	7	X-04-229-07	X-04-230-07
151	9	X-04-229-09	X-04-230-09
177	11	X-04-229-11	X-04-230-11
203	13	X-04-229-13	X-04-230-13
229	15	X-04-229-15	X-04-230-15

Wkręty blokowane / Locked screws: \varnothing 3,5 mm
 Wkręty korowe / Cortical screw: \varnothing 3,5 mm

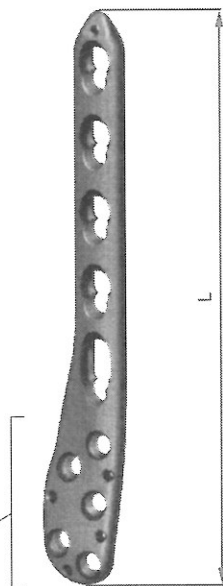

Wkręty blokowane / Locked screws: \varnothing 2,4; 2,7 mm
 Wkręty korowe / Cortical screw: \varnothing 2,4; 2,7 mm

Płytkę do kości strzałkowej dalsza tylnoboczna
 Distal fibula bone plate, posterolateral

L (mm)	otwory / holes	LEWA / LEFT	PRAWA / RIGHT
77	3	X-04-231-03	X-04-232-03
90	4	X-04-231-04	X-04-232-04
103	5	X-04-231-05	X-04-232-05
116	6	X-04-231-06	X-04-232-06
129	7	X-04-231-07	X-04-232-07
155	9	X-04-231-09	X-04-232-09
181	11	X-04-231-11	X-04-232-11
207	13	X-04-231-13	X-04-232-13
233	15	X-04-231-15	X-04-232-15

Wkręty blokowane / Locked screws: \varnothing 3,5 mm
 Wkręty korowe / Cortical screw: \varnothing 3,5 mm

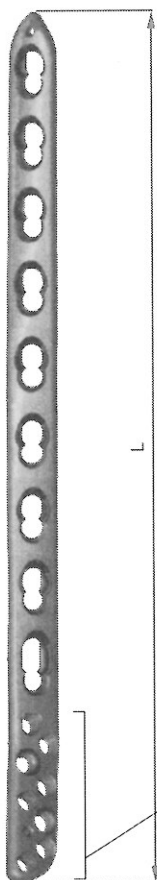

Wkręty blokowane / Locked screws: \varnothing 2,4; 2,7 mm
 Wkręty korowe / Cortical screw: \varnothing 2,4; 2,7 mm

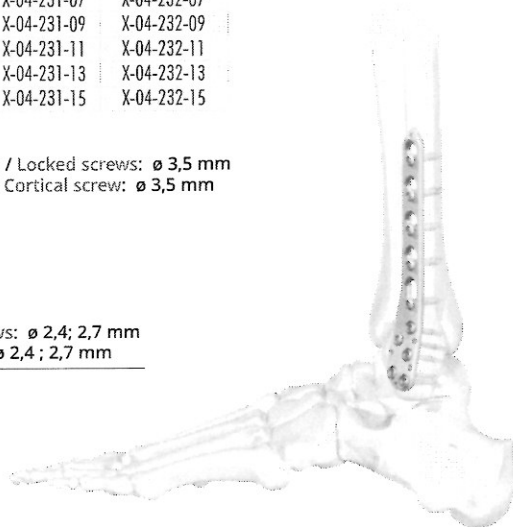

Płytko do kości strzałkowej dalsza
Distal lateral fibula bone plate

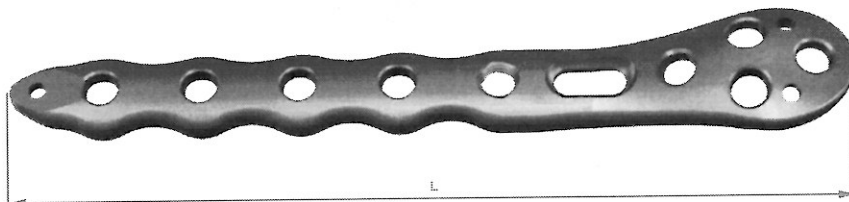

L (mm)	otwory blokowane (trzon/głowa) locked holes (shaft/head)	Nr kat Ref. no.
77	3/5	X-04-350-03
89	4/5	X-04-350-04
101	5/5	X-04-350-05
113	6/5	X-04-350-06
125	7/5	X-04-350-07
137	8/5	X-04-350-08
149	9/5	X-04-350-09
161	10/5	X-04-350-10
173	11/5	X-04-350-11
185	12/5	X-04-350-12

Wkręty blokowane / Locked screws: \varnothing 3,5 mm
Wkręty korowe / Cortical screws: \varnothing 3,5 mm

Płytko do kości strzałkowej dalsza
Distal lateral fibula bone plate

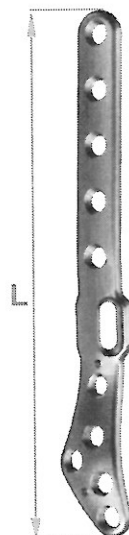

L (mm)	otwory	LEWA	PRAWA
85	4/5	X-04-348-05	X-04-347-05
108	4/7	X-04-348-07	X-04-347-07
131	4/9	X-04-348-09	X-04-347-09
154	4/11	X-04-348-11	X-04-347-11

Wkręty blokowane / Locked screws: \varnothing 3,5 mm
Wkręty korowe / Cortical screws: \varnothing 3,5 mm

Wkręty blokowane samogwintujące
Self-tapping locked screws



D = 3,5 mm		
L (mm)	S2,5	T15
10-60 (co 2 mm)	X-01-11-L	X-01-223-L
35	X-01-11-L	X-01-223-L
45	X-01-11-L	X-01-223-L
65-90 (co 5 mm)	X-01-11-L	X-01-223-L

D = 2,7 mm		
L (mm)	S2,5	T15
10-50 (co 2 mm)	X-01-202-L	X-01-224-L
35	X-01-202-L	X-01-224-L
45	X-01-202-L	X-01-224-L
55-60 (co 5 mm)	X-01-202-L	X-01-224-L

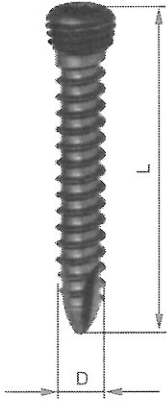

Wkręty blokowane samowierzące
Self-drilling locked screws



D = 3,5 mm		
L (mm)	S2,5	T15
10-60 (co 2 mm)	X-01-206-L	X-01-214-L
35	X-01-206-L	X-01-214-L
45	X-01-206-L	X-01-214-L
65-90 (co 5 mm)	X-01-206-L	X-01-214-L

D = 2,7 mm		
L (mm)	S2,5	T15
10-50 (co 2 mm)	X-01-228-L	X-01-230-L
35	X-01-228-L	X-01-230-L
45	X-01-228-L	X-01-230-L
55-60 (co 5 mm)	X-01-228-L	X-01-230-L



Wkręty blokowane MULTI samogwintujące
MULTI locked self-tapping screws



L (mm)	T15
10-60 (co 2 mm)	X-01-322-L
65-95 (co 5 mm)	X-01-322-L

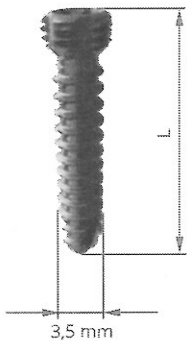

Wkręty blokowane do kości gąbczastej
Cancellous locked screws



L (mm)	S2,5	T15
6-96 (co 2 mm)	X-01-314-L	X-01-372-L

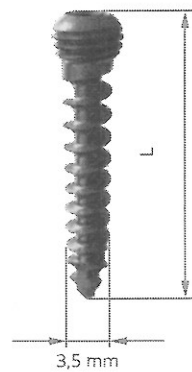

Wkręty do kości drobnych, korowe, samogwintujące Cortical self-tapping screws for small bones fragments

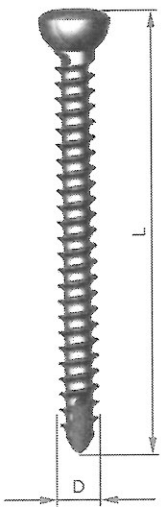

D = 2,4 mm		
L (mm)	S2,5	T8
6-40 (co 2 mm)	X-01-239-L	X-01-240-L

D = 3,5 mm		
L (mm)	S2,5	T15
8-90 (co 2 mm)	X-01-51-L	X-01-221-L

D = 2,7 mm		
L (mm)	S2,5	T8
6-40 (co 2 mm)	X-01-48-L	X-01-216-L

D = 4,5 mm		
L (mm)	S3,5	T25
12-90 (co 2 mm)	X-01-04-L	X-01-218-L
95-115 (co 5 mm)	X-01-04-L	X-01-218-L

Wkręty do kości gąbczastej samogwintujące Cancellous self-tapping screws

SYSTEM 5,0

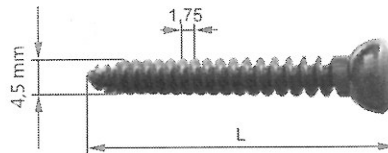

L (mm)	S3,5
20-120 (co 5 mm)	X-01-319-L

Wkręty do kości łódkowatej samogwintujące Navicular self-tapping screws

SYSTEM 3,5

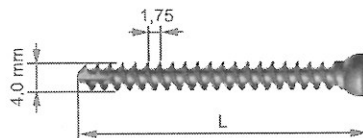

L (mm)	S2,5
8-60 (co 2 mm)	X-01-27-L
35	X-01-27-L
45	X-01-27-L
55	X-01-27-L
65-70 (co 5 mm)	X-01-27-L

Wkręty blokowane samogwintujące
Self-tapping locked screws

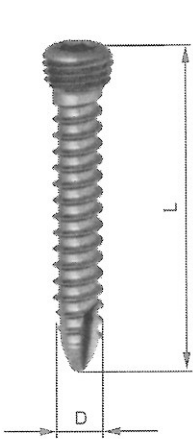

D = 2,4 mm		
L (mm)	S2,5	T8
10-40 (co 2 mm)	X-01-200-L	X-01-208-L

D = 2,7 mm		
L (mm)	S2,5	T8
10-48 (co 2 mm)	X-01-201-L	X-01-209-L
50-60 (co 5 mm)	X-01-201-L	X-01-209-L

Wkręty blokowane samowierzące
Self-drilling locked screws



D = 2,4 mm		
L (mm)	S2,5	T8
10-40 (co 2 mm)	X-01-225-L	X-01-226-L

D = 2,7 mm		
L (mm)	S2,5	T8
10-48 (co 2 mm)	X-01-227-L	X-01-229-L
50-60 (co 5 mm)	X-01-227-L	X-01-229-L

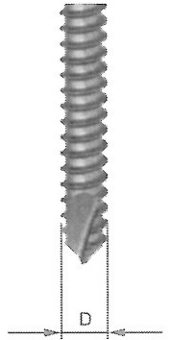

Wkręty blokowane MULTI samogwintujące
MULTI locked self-tapping screws

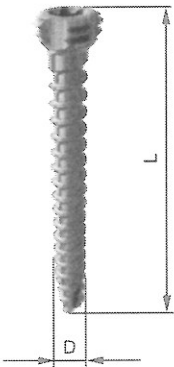

L (mm)	T8	
	D = 2,4 mm	D = 2,7 mm
10-40 (co 2 mm)	X-01-298-L	X-01-325-L

Wkręty blokowane zaślepiające
Screw hole insert



S2,5	T8
X-01-200-02	X-01-208-02



Płytki kłykciowa udowa
Condylar femoral plate

L (mm)	Ø S3,5
20-145 (co 5 mm)	X-01-204-L

Wkręt blokowany kaniulowany / Locked cannulated screws: \varnothing 7,3 mm

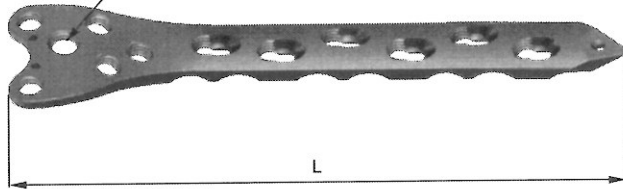

L (mm)	otwory holes	LEWA / LEFT	PRAWA / RIGHT
170	6	X-04-129-06	X-04-130-06
206	8	X-04-129-08	X-04-130-08
242	10	X-04-129-10	X-04-130-10
278	12	X-04-129-12	X-04-130-12
314	14	X-04-129-14	X-04-130-14
350	16	X-04-129-16	X-04-130-16
386	18	X-04-129-18	X-04-130-18
422	20	X-04-129-20	X-04-130-20
458	22	X-04-129-22	X-04-130-22

Wkręty blokowane / Locked screws: \varnothing 5,0 mm
Wkręty korowe / Cortical screw: \varnothing 4,5 mm

Płytki do dalszej nasady kości udowej boczna
Lateral distal femoral plate

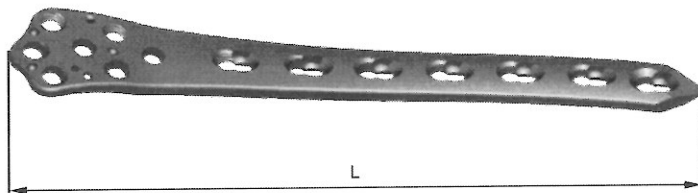

L (mm)	otwory holes	LEWA / LEFT	PRAWA / RIGHT
156	5	X-04-179-05	X-04-180-05
196	7	X-04-179-07	X-04-180-07
236	9	X-04-179-09	X-04-180-09
276	11	X-04-179-11	X-04-180-11
316	13	X-04-179-13	X-04-180-13

Wkręty blokowane / Locked screws: \varnothing 5,0 mm
Wkręty korowe / Cortical screw: \varnothing 4,5 mm



A x B	otwory holes	Nr kat. Ref. no.
34,2 x 18	4	X-04-318-04
42,7 x 31	8	X-04-318-08

Wkręty blokowane / Locked screws: \varnothing 3,5 mm
Wkręty korowe / Cortical screw: \varnothing 3,5 mm

Nakładka do stabilizacji złamań okołoprotezowych
Attachment plate for treatment of periprosthetic fracture

Zestaw do mocowania nakładki do stabilizacji złamań
Set of for treatment of periprosthetic fracture

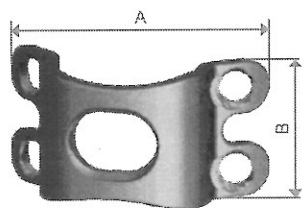

4-otworowa Typ B

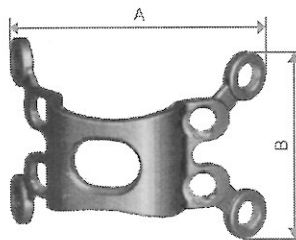

8-otworowa Typ B



\varnothing S3,5 \varnothing T25

X-01-299-01 X-01-397-01

Płytko do bliższej nasady kości udowej
Proximal femoral plate

L (mm)	otwory holes	LEWA / LEFT	PRAWA / RIGHT
108	2	X-04-334-02	X-04-335-02
144	4	X-04-334-04	X-04-335-04
180	6	X-04-334-06	X-04-335-06
234	9	X-04-334-09	X-04-335-09
288	12	X-04-334-12	X-04-335-12
342	15	X-04-334-15	X-04-335-15
396	18	X-04-334-18	X-04-335-18

Wkręty blokowane / Locked screws: \varnothing 5,0 mm
Wkręty korowe / Cortical screw: \varnothing 4,5 mm

Wkręty blokowane / Locked screws: \varnothing 5,0 mm

L (mm)	\varnothing S3,5	\varnothing T25
14-60 (co 2 mm)	X-01-17-L	X-01-222-L

Wkręty kaniulowane / Cannulated screws: \varnothing 6,5 mm

L (mm)	\varnothing S3,5	\varnothing T25
25-140 (co 5 mm)	X-01-235-L	X-01-369-L

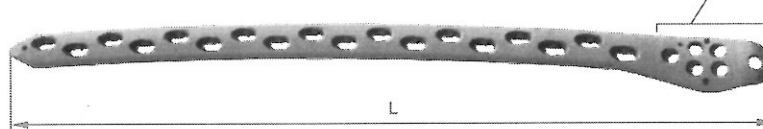

Płytko do bliższej nasady kości udowej
Proximal femoral plate

L (mm)	otwory holes	LEWA / LEFT	PRAWA / RIGHT
139	2	X-04-181-02	X-04-182-02
175	4	X-04-181-04	X-04-182-04
211	6	X-04-181-06	X-04-182-06
247	8	X-04-181-08	X-04-182-08
283	10	X-04-181-10	X-04-182-10
319	12	X-04-181-12	X-04-182-12
355	14	X-04-181-14	X-04-182-14
391	16	X-04-181-16	X-04-182-16

Wkręty blokowane / Locked screws: \varnothing 5,0 mm
Wkręty korowe / Cortical screw: \varnothing 4,5 mm

Wkręty kaniulowane / Cannulated screws: \varnothing 7,3 mm

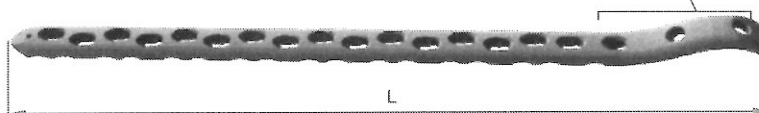

Wkręty blokowane samogwintujące
Self-tapping locked screws

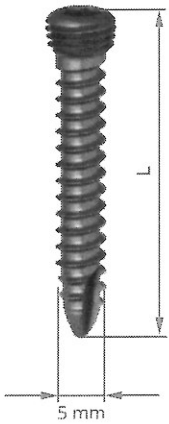

L (mm)	S3,5	T25
14-60 (co 2 mm)	X-01-17-L	X-01-222-L
35	X-01-17-L	X-01-222-L
45	X-01-17-L	X-01-222-L
65-115 (co 5 mm)	X-01-17-L	X-01-222-L

Wkręty blokowane samowierzące
Self-drilling locked screws

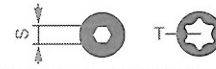

L (mm)	S3,5	T25
14-60 (co 2 mm)	X-01-207-L	X-01-215-L
35	X-01-207-L	X-01-215-L
45	X-01-207-L	X-01-215-L
65-115 (co 5 mm)	X-01-207-L	X-01-215-L

Wkręt blokowany kaniulowany samowierzący
Self-drilling cannulated locked screw

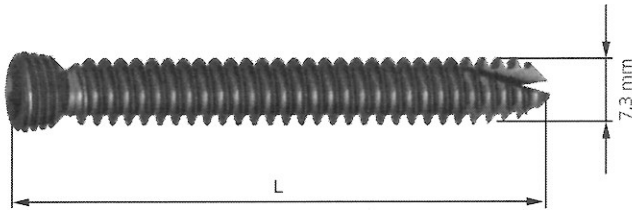

L (mm)	S3,5	T25
30-145 (co 5 mm)	X-01-204-L	X-01-212-L

Wkręty blokowany do kości gąbczastej
Cancellous locked screws

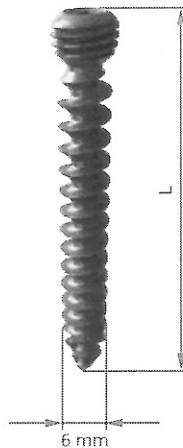

L (mm)	S3,5	T25
25-125 (co 5 mm)	X-01-306-L	X-01-367-L

Wkręty blokowane kaniulowane samowierzące
Self-drilling cannulated locked screw

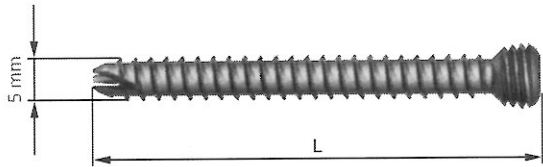

L (mm)	⊙ S3,5	⊙ T25
16-60 (co 2 mm)	X-01-234-L	X-01-268-L
65-115 (co 5 mm)	X-01-234-L	X-01-268-L

Wkręty kaniulowane z łbem stożkowym samowierzące
Self-drilling cannulated conical screws

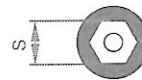
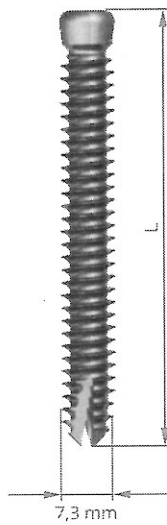

L (mm)	⊙ S3,5
50-95 (co 5 mm)	X-01-254-L

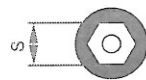

L (mm)	⊙ S3,5
50-95 (co 5 mm)	X-01-253-L

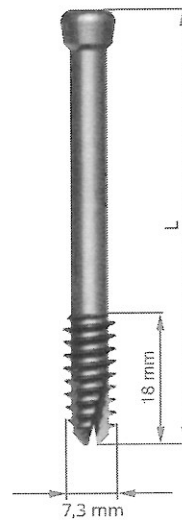

Wkręty kaniulowane z łbem stożkowym samowierzące
Self-drilling cannulated conical screws

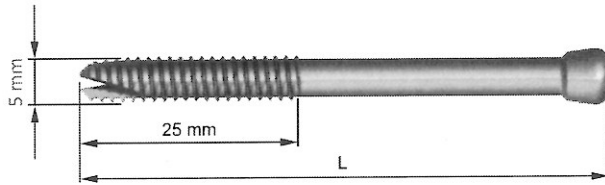

L (mm)	⊙ S3,5	⊙ T25
40-95 (co 5 mm)	X-01-252-L	X-01-267-L

Nakrętka kompresyjna do wkrętów Ø 5,0 z łbem stożkowym
Screw nut for conical screws Ø 5,0

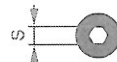

⊙ S3,5

X-01-255-01

*dedykowana do wkrętów: X-01-252-L, X-01-267-L
*dedicated to screws: X-01-252-L, X-01-267-L

Wkręty blokowane dystansowe
Spacer



⊙ S3,5

⊙ T25

X-01-207-06

X-01-215-06

Wkręty blokowane zaślepiające
Screw hole insert

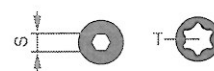
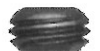

⊙ S3,5

⊙ T25

X-01-207-04

X-01-215-04

Wkręty blokowane okołoprotezowe
Periprosthetic locked screws



L (mm)

⊙ S3,5

⊙ T25

8-18
(co 2 mm)

X-01-296-L

X-01-297-L