

System informacji wizualnej
w przestrzeni mikołowskich budynków
przy Rynku, ul. św. Wojciecha i ul. Jana Pawła II

Pozwolić dotrzeć w wybrane miejsce
bez potrzeby „przewodnika”

3 budynki

różne lokalizacje i stylistyka (struktura) wnętrza

3 rodzaje użytkowników systemu

najemcy i obsługa, goście najemców, goście wydarzeń

Cały zakres grup wiekowych

młodzież – seniorzy

Rotacja wynajmujących

możliwość modyfikacji systemu

3 budynki

różne lokalizacje i stylistyka (struktura) wnętrza

od ogółu do szczegółu

budynek > piętro > sala

3 rodzaje użytkowników systemu

najemcy i obsługa, goście najemców, goście wydarzeń

czytelny system

system czytelny dla każdego
z ewentualnym kreatywnym akcentem

Cały zakres grup wiekowych

młodzież – seniorzy

prosty przejrzysty design

styl grafiki nie może być dominujący
a zarazem powinien ocieplić wnętrze

Rotacja wynajmujących

możliwość modyfikacji systemu

neutralne nazewnictwo — numeracja

system numeryczny sal + dodatkowe wyeksponowanie
sal konferencyjnych, kuchni, etc.

Analiza lokalizacji umieszczenie informacji wizualnej

- analiza przestrzeni
- analiza dostępności miejsca
- ścieżki użytkownika
- newralgiczne momenty



R2/ POZIOM 0

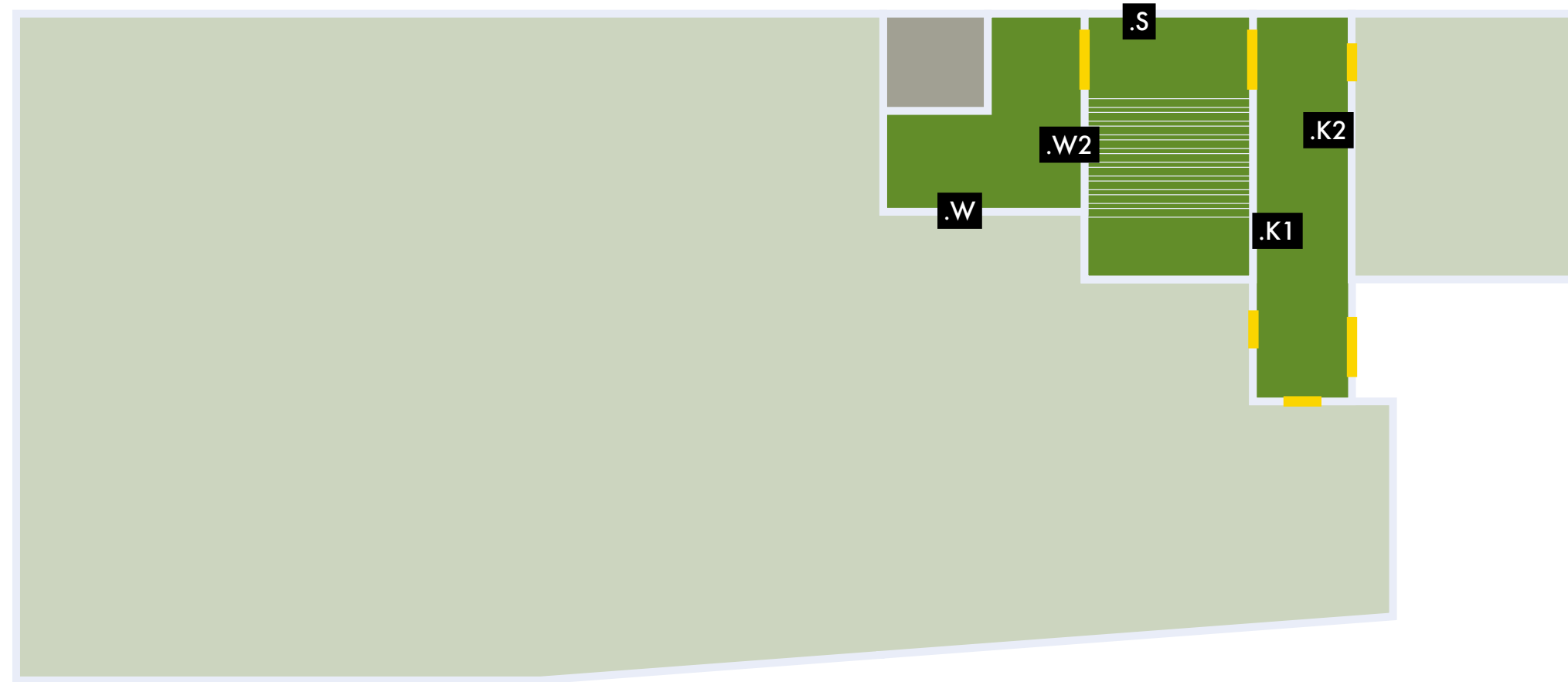

R2/ POZIOM -1

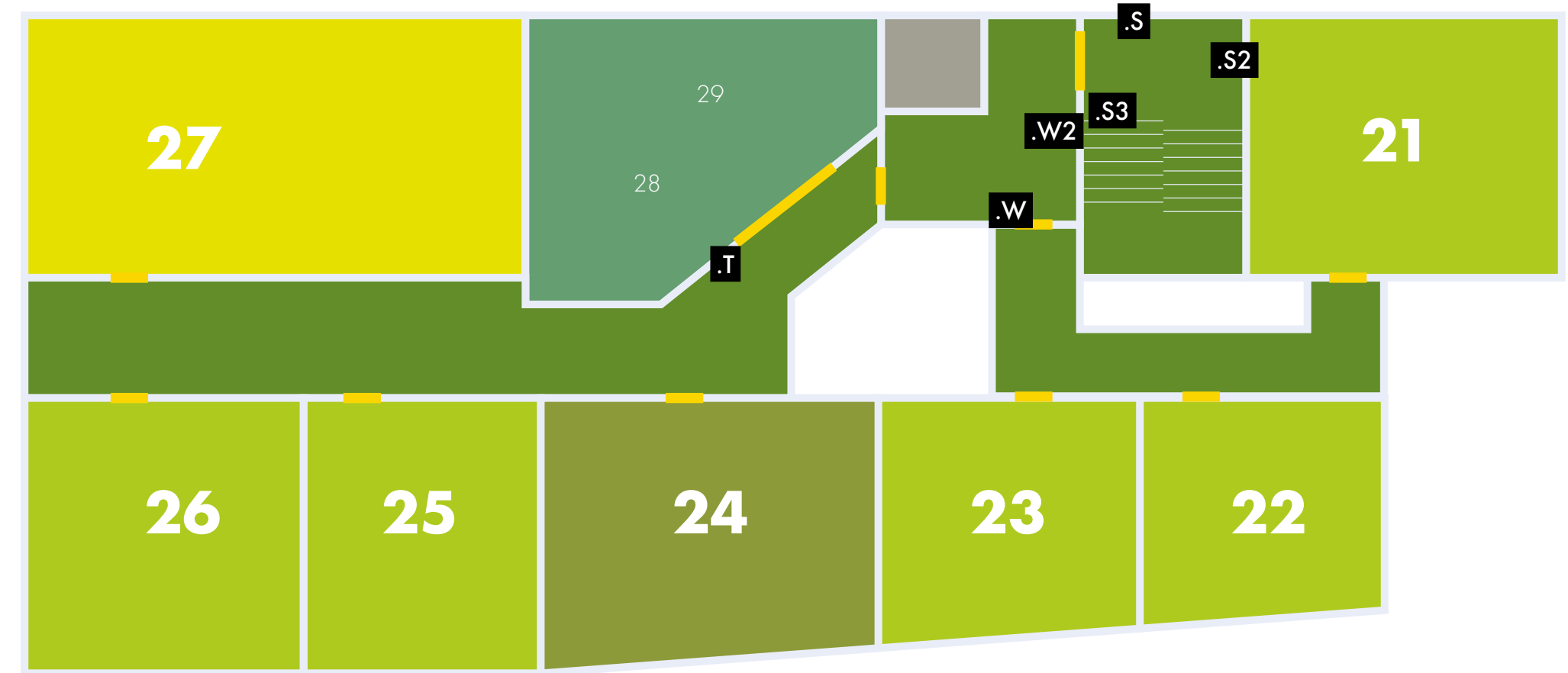

R2/ POZIOM 2



R2/ POZIOM 1



R2/ POZIOM 3

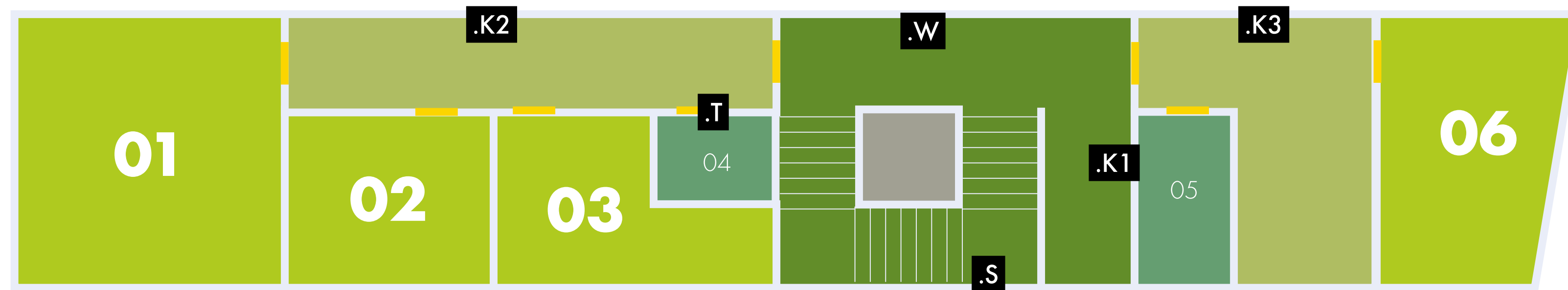

W14/ POZIOM 0



W14/ POZIOM 0



JP4/ POZIOM 0



JP4/ POZIOM 1

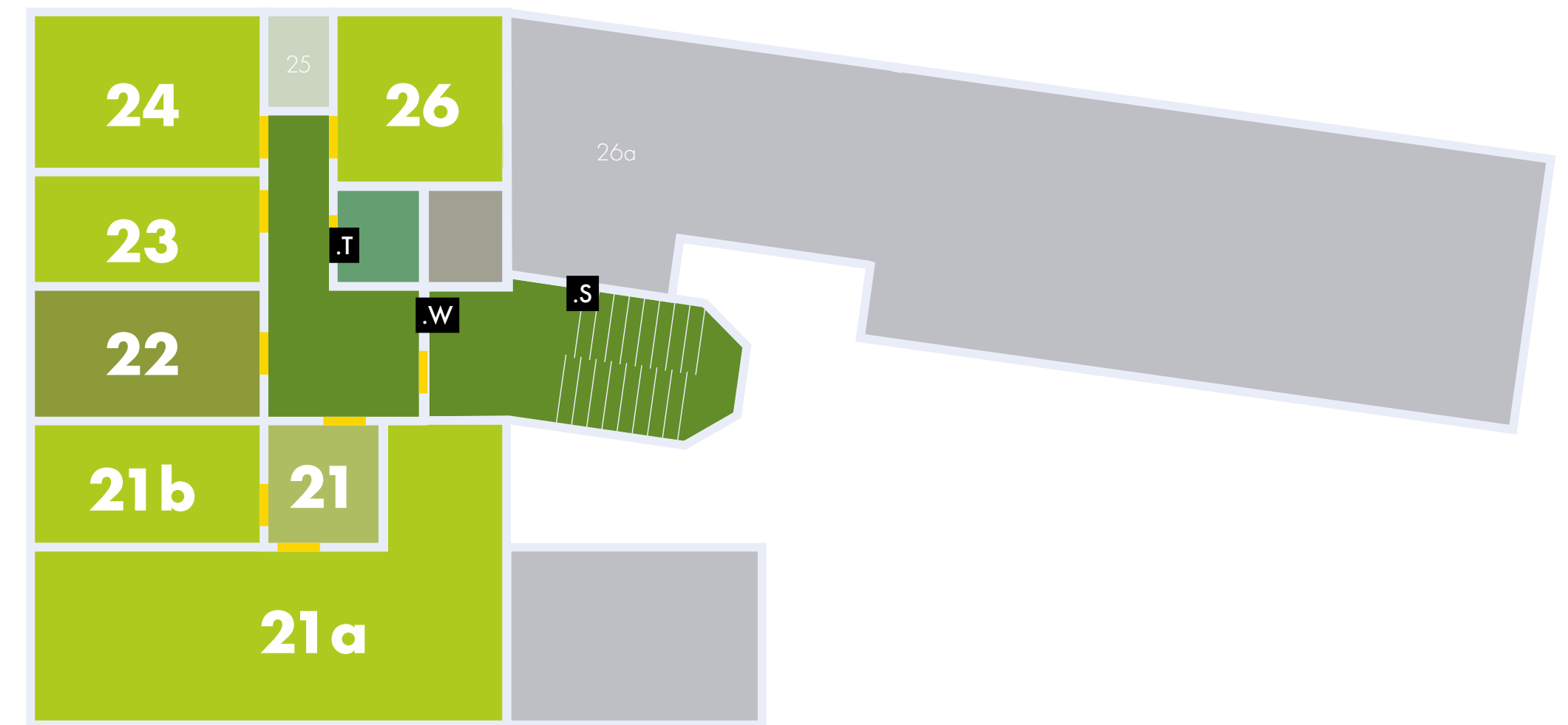

JP4/ POZIOM 2

Koncepcja wizualna



3

Botaniczna
Botanical Hall

Sale 31–33
Rooms 31–33

Toalety
Toilets



2

Dworcowa
Station Hall

Sale 21–29
Rooms 21–29

Toalety
Toilets



1

Ratuszowa
Town Hall

Sale 11–19
Rooms 11–19

Toalety
Toilets



15,00



Toalety

7,00

Toilets 3,50

9,00



11,00



Sala Konferencyjna
Conference Room

27

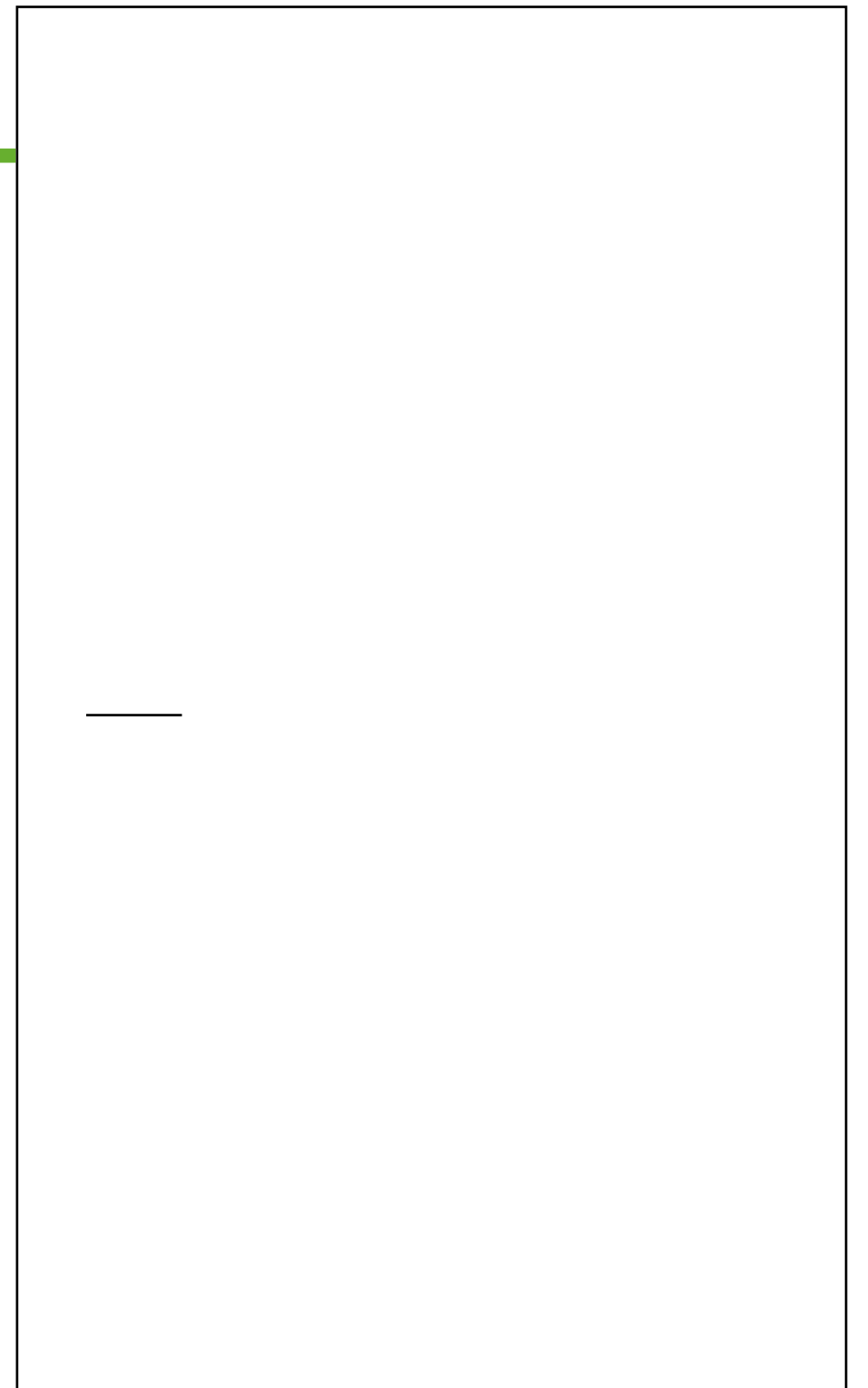

Wirtualny spacer

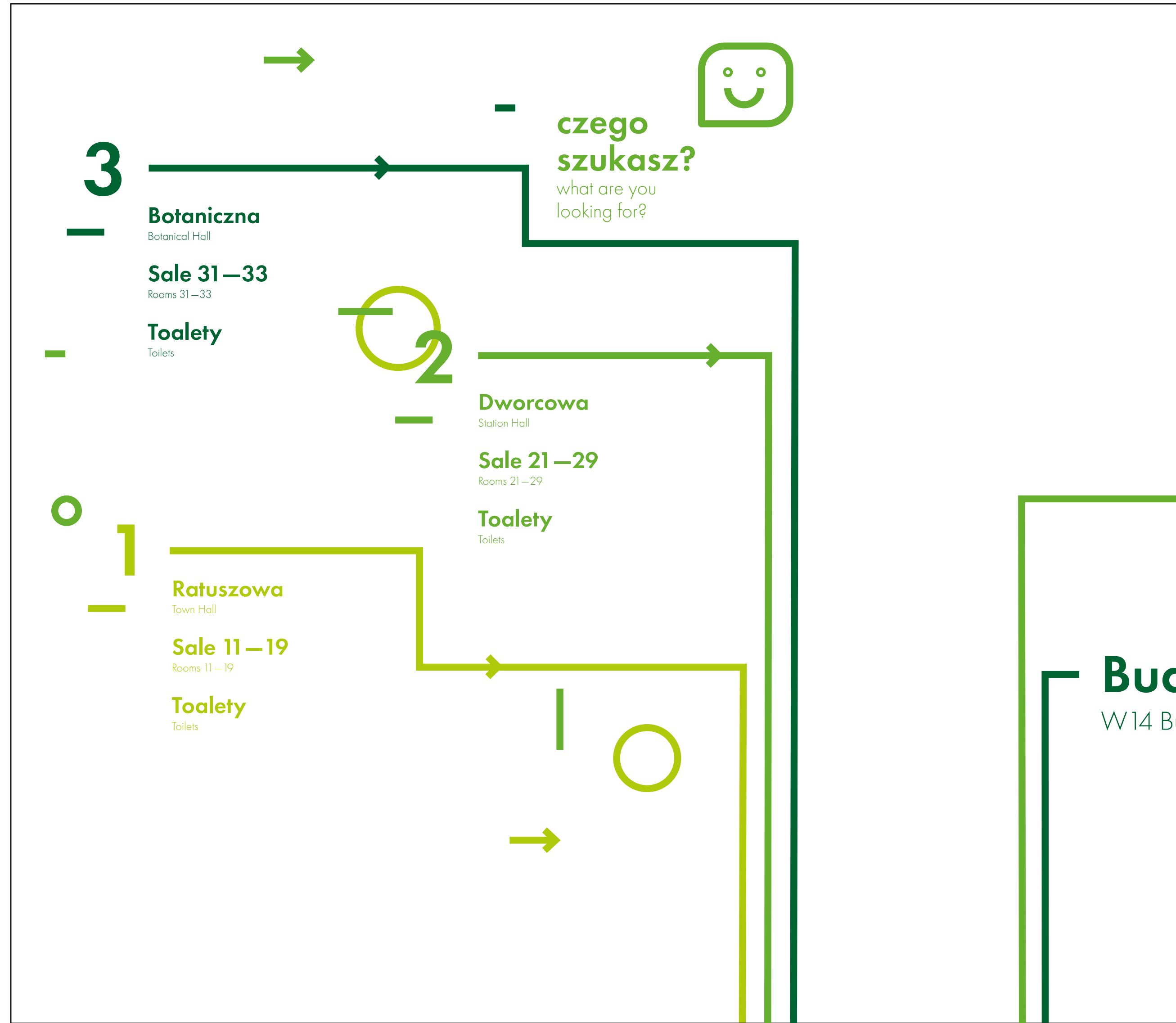



287 cm

300 cm

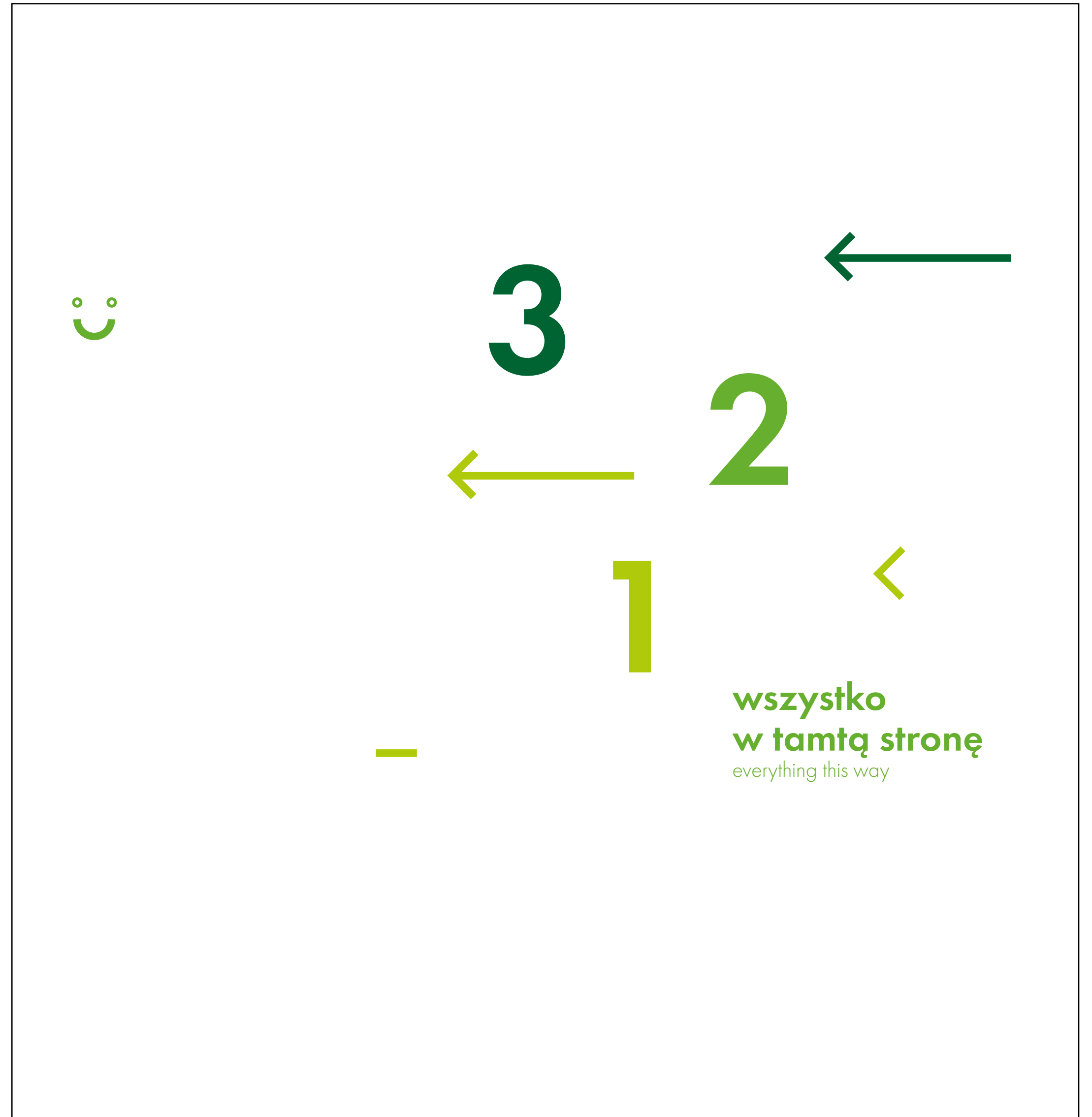

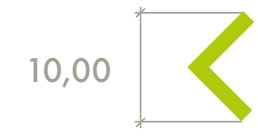

300 cm

135 cm

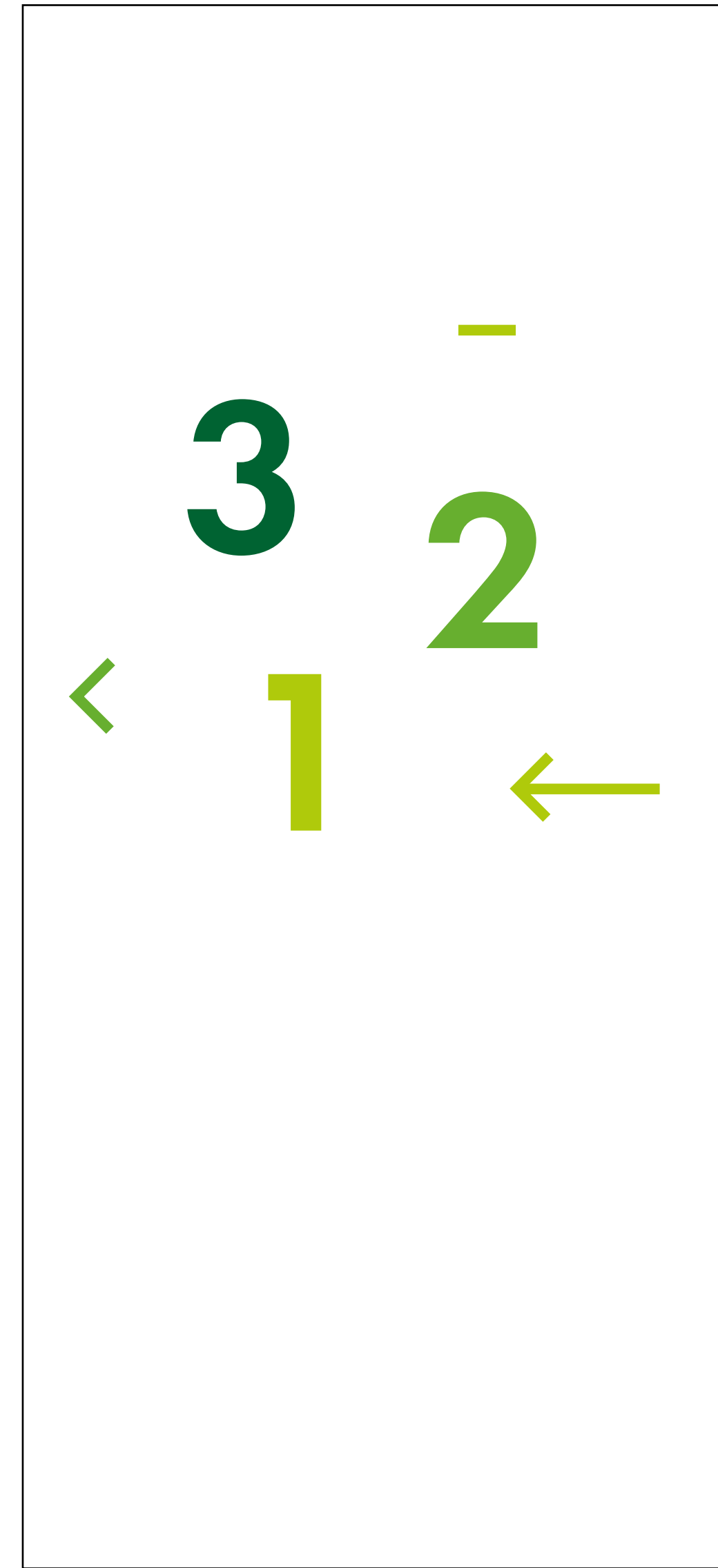



150 cm

300 cm

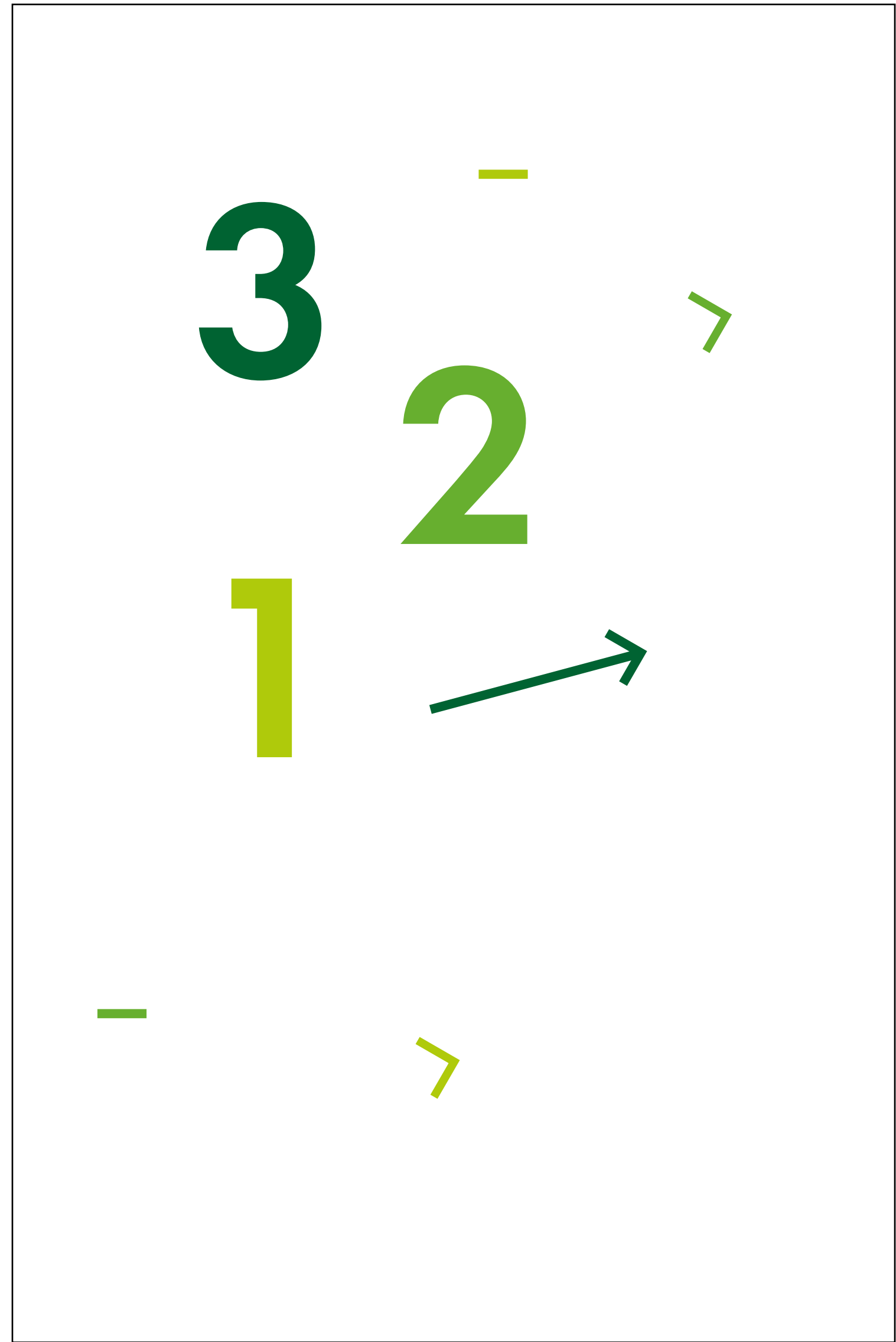

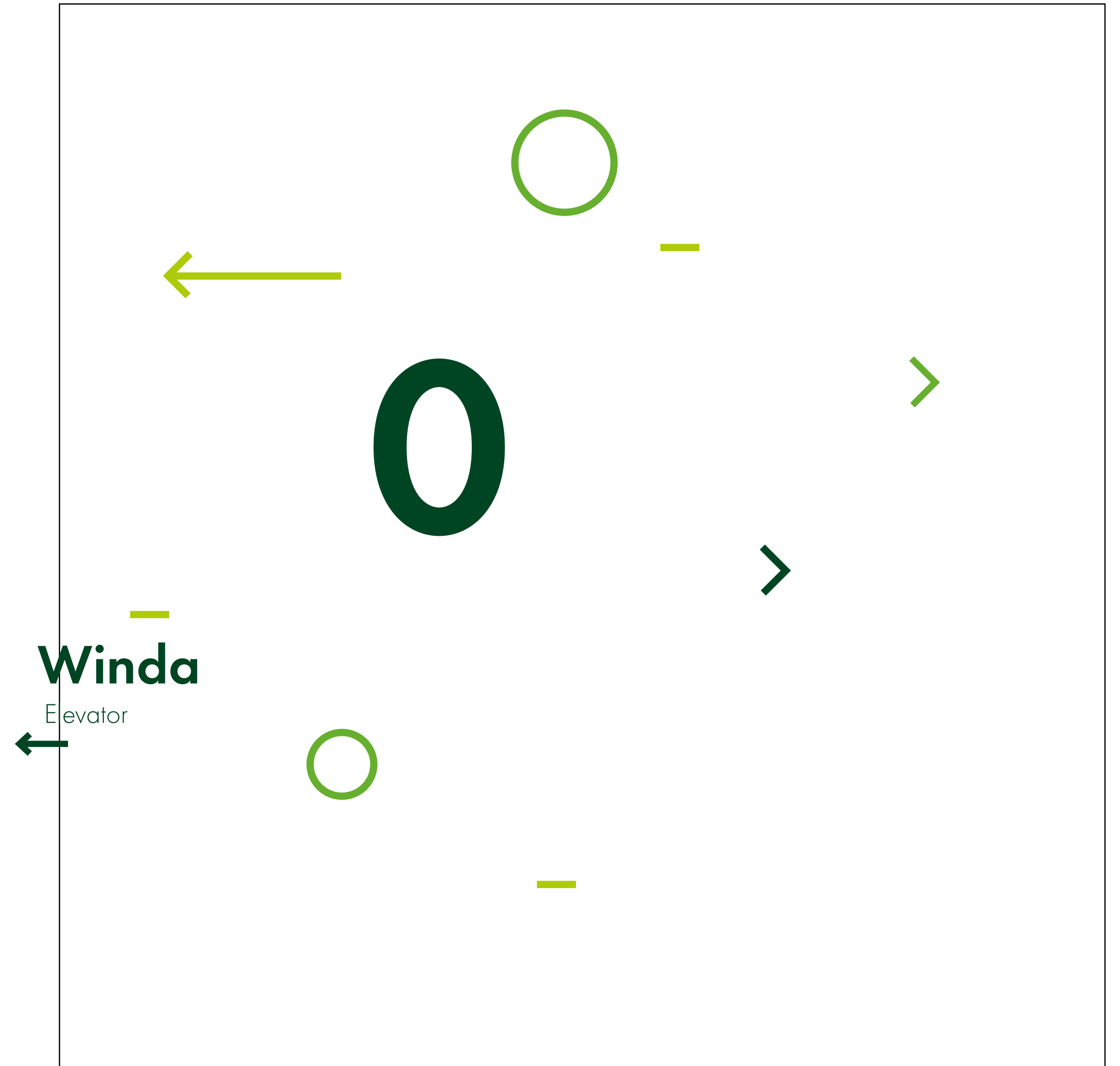



300 cm

220 cm

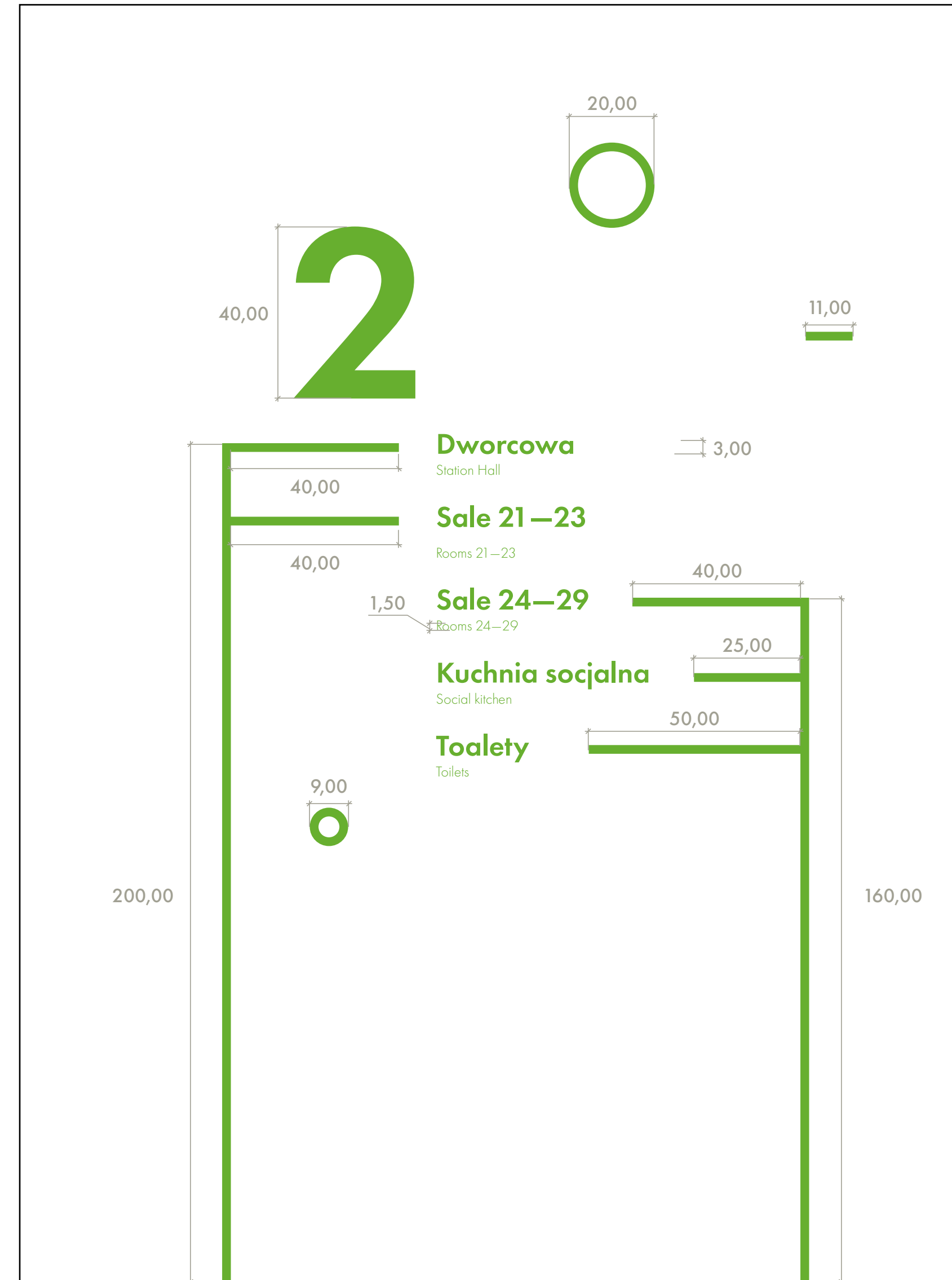



155 cm

300 cm

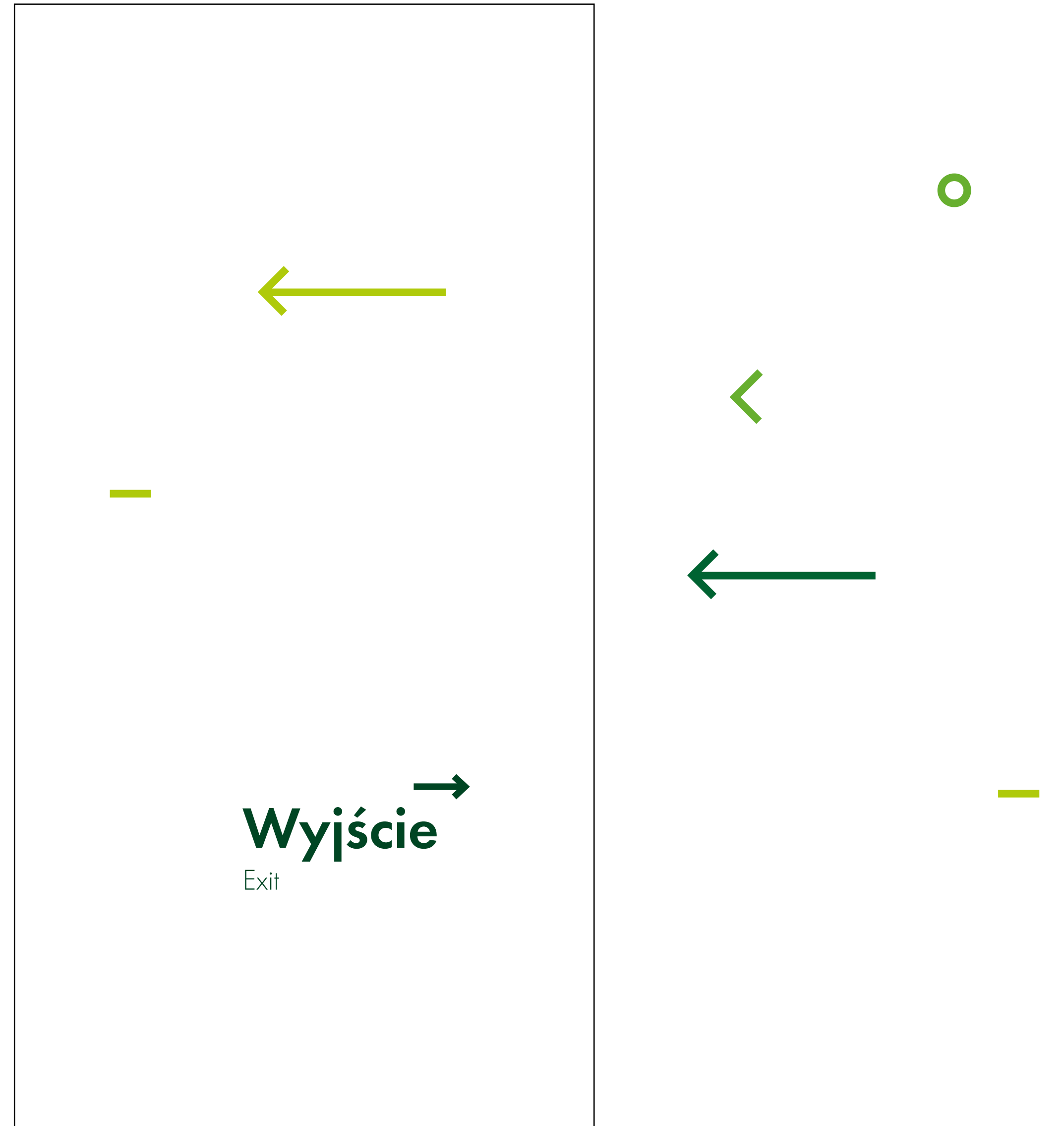



300 cm

260 cm

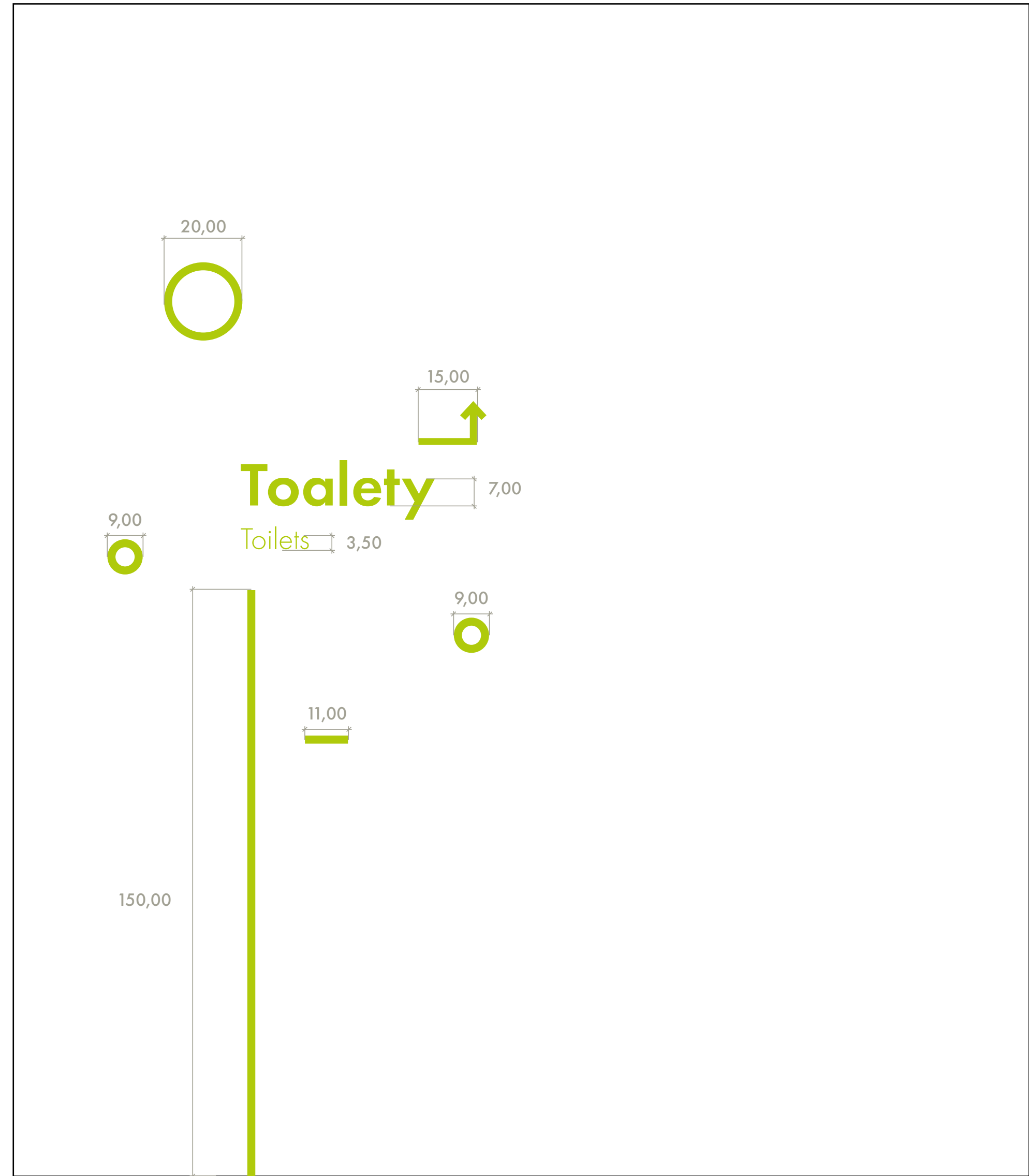

xxx cm

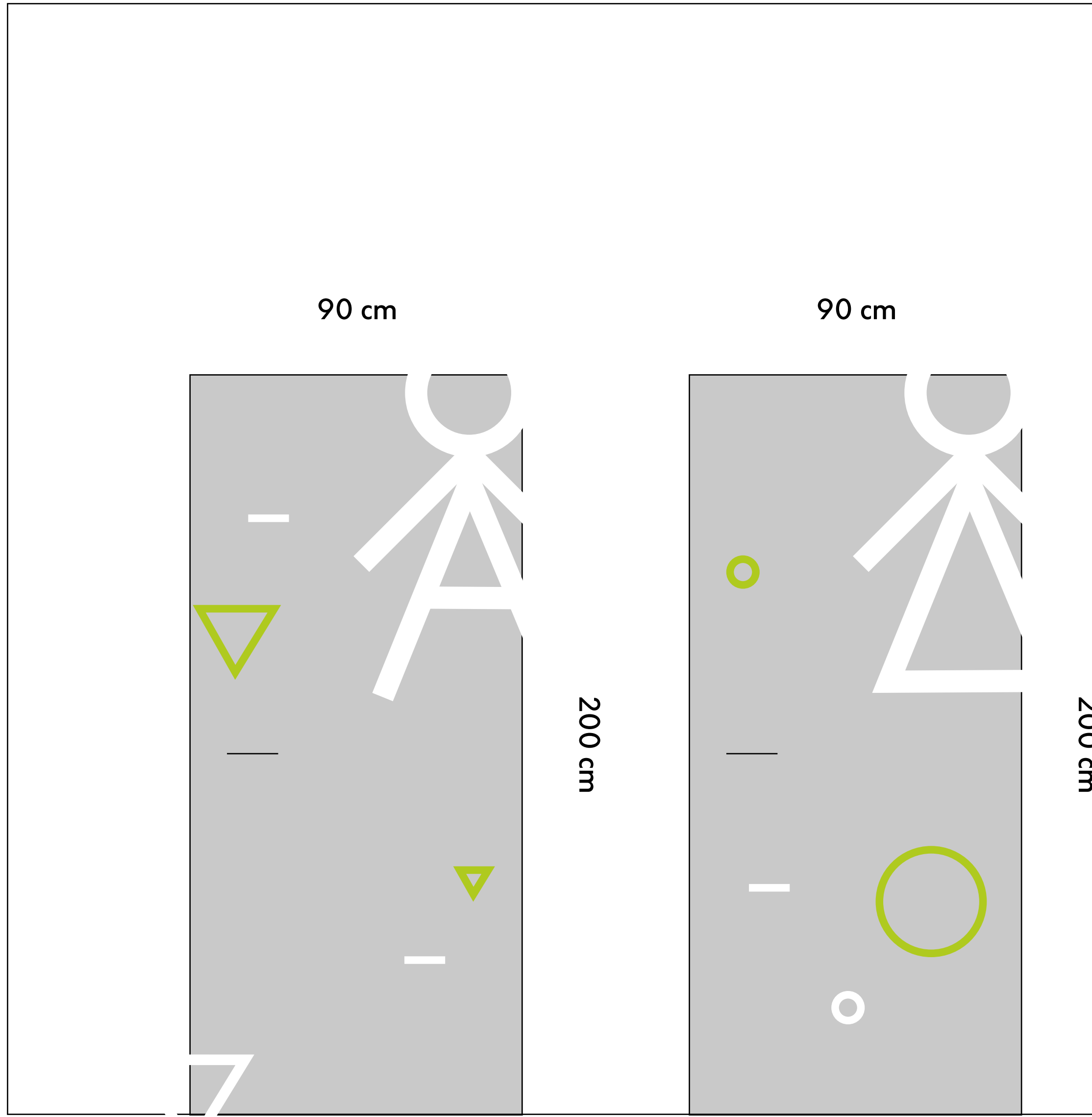

xxx cm

300 cm

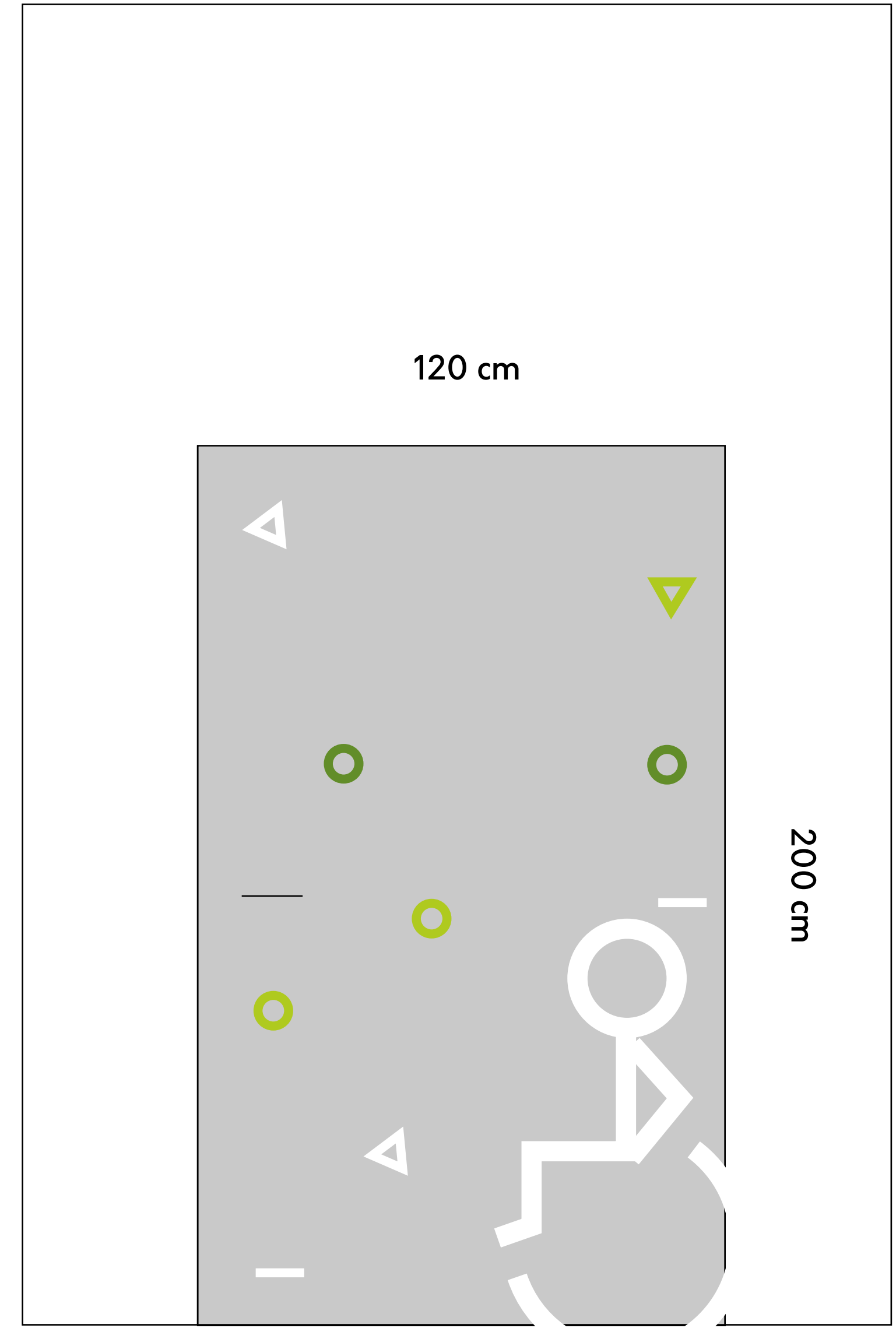

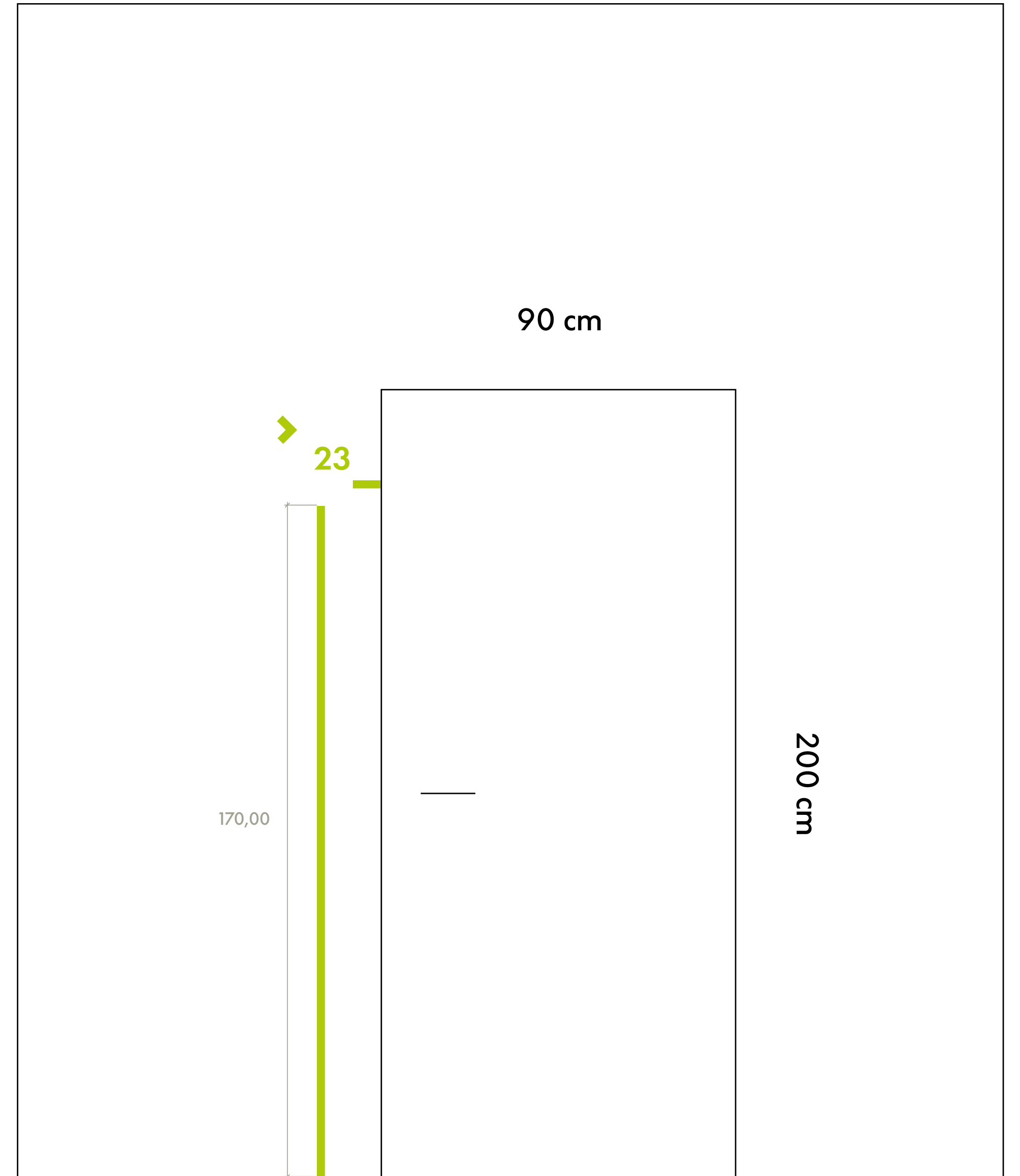

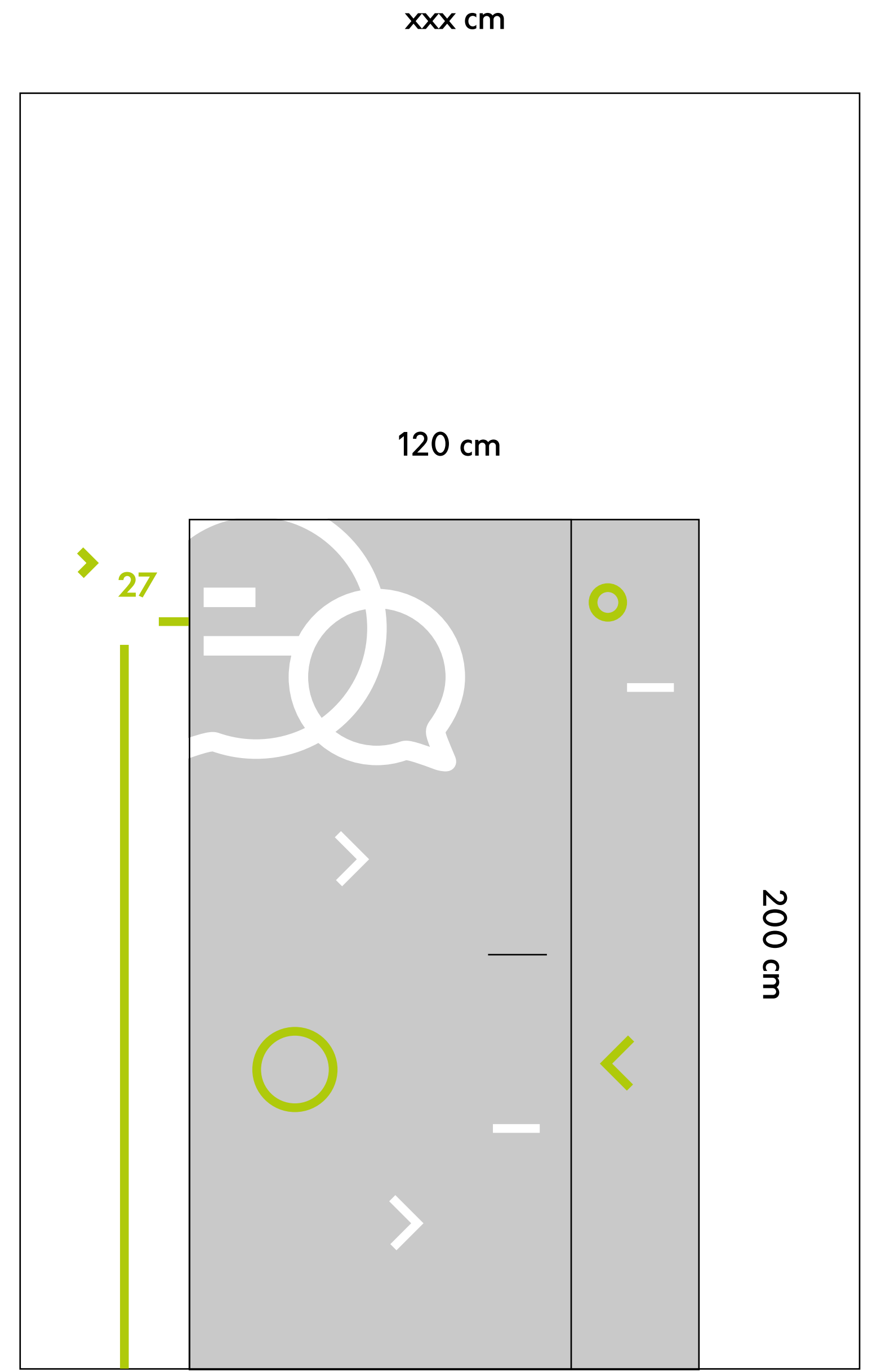

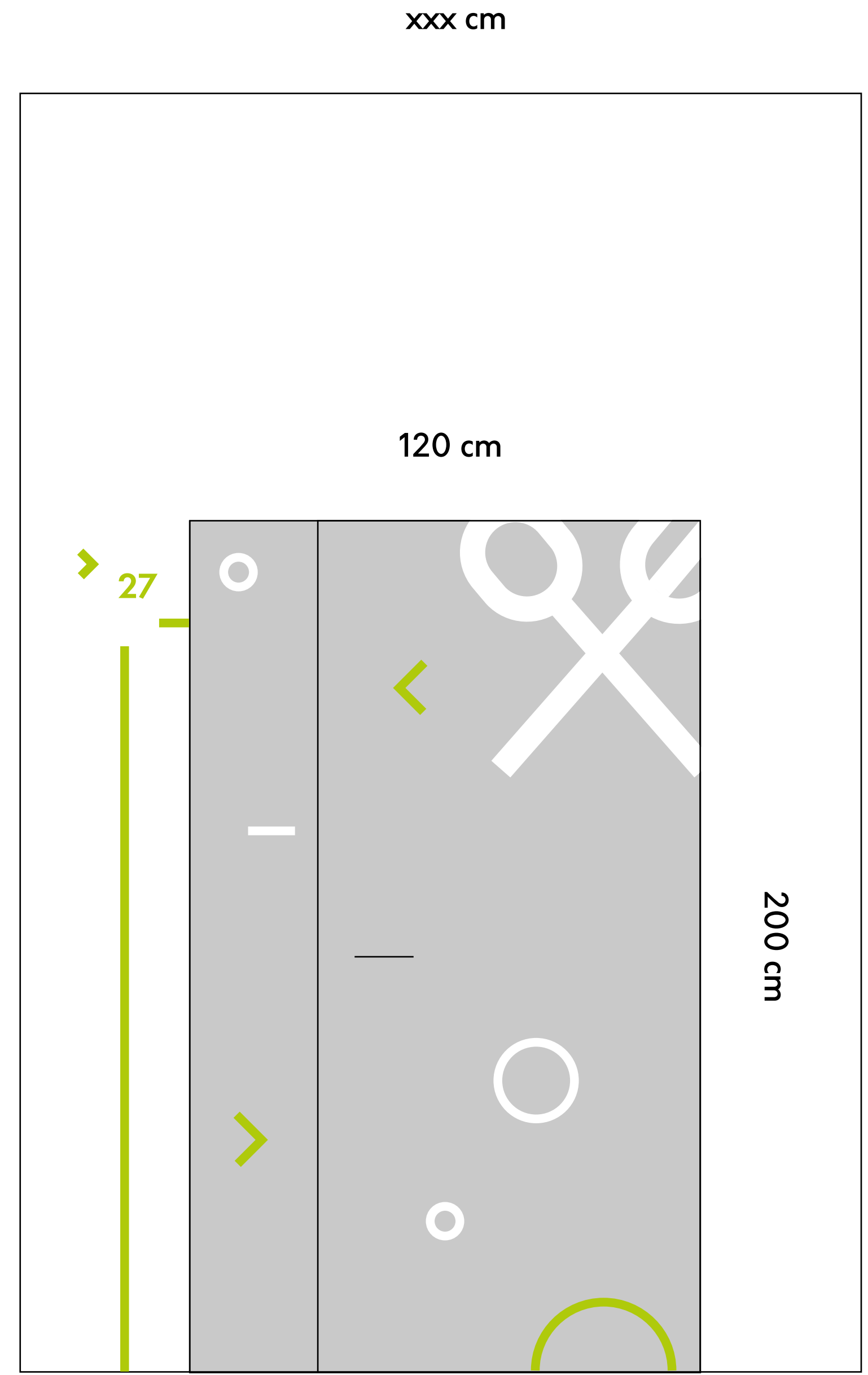





2
Strych
Sale 21-27
Toalety

1
Male Placizy
Dzisz Placizy
Sale 11-19
Toalety
Kuchnia

czyszczenie
zabijanie
bakterii

Budynki W2
Budynki W4



Wdrożenie

- odległości
- powierzchnie
- wymiary

R2

	83m²
ściana	22 mb
podłoga	260 mb
cyfry	22 (3,3 m²)
drzwi	31,5 m²

W14

	17 m²
ściana	10 mb
podłoga	50 mb
duże cyfry	4 (0,6 m²)
drzwi	15,5 m²

JP4

	16 m²
ściana	5 mb
podłoga	125 mb
cyfry	12 (1,8 m²)
drzwi	26,5m²